



Celebrating 1974 **50** 2024 Years

CALIBER INDUSTRIAL SUPPLY
5500 Tomken Rd, Unit #2
Mississauga, ON L4W 2Z4
www.caliberindustrial.com
sales@caliberindustrial.com

Distributor of The Year
2023 AWARD Winner

INDICAL
INDUSTRIAL STRENGTH
SELL-A-RAMA 2024
ORLANDO - FLORIDA
MARCH 18-23
PARTNERSHIP. COMMITMENT. RESULTS.

By **Indica**
MARKETING GROUP.

****SUMMER 2024 PROMOTIONS****

*Valid
Through
October 31,
2024*



SCAN QR Code for latest Promotions





HIGH PERFORMANCE TAPS



CLEVELAND

Black Oxide recommended for Carbon Steels and Stainless Steels — **Hardlube** recommended for Stainless, Harder Steels and Cast Iron.

Size	Spiral Point			
	Hardlube		Black Oxide	
	PER-960SP		PER-862SP	
2-56 NC 2B 3FLT	C96001	\$28.22	C86201	\$23.61
3-48 NC 2B 3FLT	C96002	\$22.52	C86202	\$18.87
4-40 NC 2B 3FLT	C96003	\$18.50	C86203	\$15.52
4-48 NF 2B 3FLT	C96004	\$18.50	C86204	\$15.52
5-40 NC 2B 3FLT	C96005	\$18.50	C86205	\$15.52
6-32 NC 2B 3FLT	C96006	\$15.32	C86206	\$12.93
6-40 NF 2B 3FLT	C96007	\$15.32	C86207	\$12.93
8-32 NC 2B 3FLT	C96008	\$15.32	C86208	\$12.93
8-36 NF 2B 3FLT	C96009	\$15.32	C86209	\$12.93
10-24 NC 2B 3FLT	C96010	\$16.66	C86210	\$12.93
10-32 NF 2B 3FLT	C96011	\$16.66	C86211	\$12.93
12-24 NC 2B 3FLT	C96012	\$16.66	C86212	\$12.93
12-28 NF 2B 3FLT	C96013	\$16.66	C86213	\$12.93
1/4-20 NC 2B 3FLT	C96014	\$18.02	C86214	\$14.36
1/4-28 NF 2B 3FLT	C96015	\$18.25	C86215	\$14.36
5/16-18 NC 2B 3FLT	C96016	\$20.06	C86216	\$16.09
5/16-24 NF 2B 3FLT	C96017	\$20.34	C86217	\$16.09
3/8-16 NC 2B 3FLT	C96018	\$22.64	C86218	\$18.10
3/8-24 NF 2B 3FLT	C96019	\$22.73	C86219	\$18.10
7/16-14 NC 2B 3FLT	C96020	\$28.22	C86220	\$23.55
7/16-20 NF 2B 3FLT	C96021	\$28.22	C86221	\$23.55
1/2-13 NC 2B 3FLT	C96022	\$32.62	C86222	\$27.29
1/2-20 NF 2B 3FLT	C96023	\$32.62	C86223	\$27.29
9/16-12 NC 2B 3FLT	C96024	\$45.53	C86224	\$42.53
9/16-18 NF 2B 3FLT	C96025	\$45.53	C86225	\$42.53
5/8-11 NC 2B 3FLT	C96026	\$59.15	C86226	\$49.41
5/8-18 NF 2B 3FLT	C96027	\$59.15	C86227	\$49.41
3/4-10 NC 2B 4FLT	C96028	\$92.77	C86228	\$76.59
3/4-16 NF 2B 4FLT	C96029	\$92.77	C86229	\$76.59
7/8-9 NC 2B 4FLT	C96030	\$137.69	C86230	\$127.63
7/8-14 NF 2B 4FLT	C96031	\$137.69	C86231	\$127.63
1"-8 NC 2B 4FLT	C96032	\$183.62	C86232	\$153.22
1"-12 NF 2B 4FLT	C96033	\$183.62	C86233	\$177.95
M2.5 X 0.45 6H 3FLT	C96052	\$26.01	C86252	\$21.80
M3 X 0.5 6H 3FLT	C96034	\$24.01	C86234	\$20.10
M3.5 X 0.6 6H 3FLT	C96035	\$24.01	C86235	\$17.52
M4 X 0.7 6H 3FLT	C96036	\$24.01	C86236	\$17.52
M5 X 0.8 6H 3FLT	C96037	\$24.01	C86237	\$17.52
M6 X 1.0 6H 3FLT	C96038	\$24.01	C86238	\$17.52
M7 X 1.0 6H 3FLT	C96039	\$27.11	C86239	\$21.35
M8 X 1.0 6H 3FLT	C96040	\$28.79	C86240	\$22.26
M8 X 1.25 6H 3FLT	C96041	\$28.79	C86241	\$22.26
M10 X 1.25 6H 3FLT	C96042	\$35.10	C86242	\$29.19
M10 X 1.5 6H 3FLT	C96043	\$35.10	C86243	\$29.19
M12 X 1.25 6H 3FLT	C96044	\$36.92	C86244	\$33.90
M12 X 1.75 6H 3FLT	C96045	\$36.92	C86245	\$33.90
M14 X 1.5 6H 3FLT	C96046	\$47.56	C86246	\$37.85
M14 X 2.0 6H 3FLT	C96047	\$47.56	C86247	\$37.85
M16 X 1.5 6H 3FLT	C96048	\$62.39	C86248	\$54.14
M16 X 2.0 6H 3FLT	C96049	\$62.39	C86249	\$54.14
M18 X 1.5 6H 4FLT	C96050	\$94.47	C86250	\$81.62
M18 X 2.5 6H 4FLT	C96051	\$94.47	C86251	\$81.62

Size	Spiral Flute			
	Hardlube		Black Oxide	
	PER-980SF		PRO-981SF	
2-56 UNF 2FLT 2B	C98001	\$42.03	C98101	\$33.65
3-48 UNF 2FLT 2B	C98002	\$33.72	C98102	\$26.95
4-40 UNC 2FLT 2B	C98003	\$27.61	C98103	\$23.26
4-48 UNF 2FLT 2B	C98004	\$27.61	C98104	\$23.26
5-40 UNC 3FLT 2B	C98005	\$27.61	C98105	\$23.26
6-32 UNC 3FLT 2B	C98006	\$22.52	C98106	\$18.87
6-40 UNF 3FLT 2B	C98007	\$22.52	C98107	\$18.87
8-32 UNC 3FLT 2B	C98008	\$22.52	C98108	\$18.87
8-36 UNF 3FLT 2B	C98009	\$22.52	C98109	\$18.87
10-24 UNC 3FLT 2B	C98010	\$22.52	C98110	\$18.87
10-32 UNF 3FLT 2B	C98011	\$22.52	C98111	\$18.87
12-24 UNC 3FLT 2B	C98012	\$20.97	C98112	\$18.87
12-28 UNF 3FLT 2B	C98013	\$24.42	C98113	\$18.87
1/4-20 UNC 3FLT 2B	C98014	\$25.52	C98114	\$20.50
1/4-28 UNF 3FLT 2B	C98015	\$25.52	C98115	\$20.50
5/16-18 UNC 3FLT 2B	C98016	\$30.51	C98116	\$25.18
5/16-24 UNF 3FLT 2B	C98017	\$30.46	C98117	\$25.18
3/8-16 UNC 3FLT 2B	C98018	\$35.46	C98118	\$29.30
3/8-24 UNF 3FLT 2B	C98019	\$35.46	C98119	\$29.30
7/16-14 UNC 3FLT 2B	C98020	\$52.34	C98120	\$43.76
7/16-20 UNF 3FLT 2B	C98021	\$52.34	C98121	\$43.70
1/2-13 UNC 3FLT 2B	C98022	\$61.54	C98122	\$51.70
1/2-20 UNF 3FLT 2B	C98023	\$61.54	C98123	\$51.70
9/16-12 UNC 4FLT 2B	C98024	\$86.14	C98124	\$69.68
9/16-18 UNF 4FLT 2B	C98025	\$91.09	C98125	\$69.68
5/8-11 UNC 4FLT 2B	C98026	\$91.09	C98126	\$84.89
5/8-18 UNF 4FLT 2B	C98027	\$91.09	C98127	\$84.89
3/4-10 UNC 4FLT 2B	C98028	\$124.63	C98128	\$97.38
3/4-16 UNF 4FLT 2B	C98029	\$124.63	C98129	\$97.38
7/8-9 UNC 4FLT 2B	C98030	\$174.31	C98130	\$157.47
7/8-14 UNF 4FLT 2B	C98031	\$174.31	C98131	\$157.47
1-8 UNC 4FLT 2B	C98032	\$224.07	C98132	\$194.27
1-12 UNF 4FLT 2B	C98033	\$224.07	C98133	\$194.27
M3x0.5 3FLT 6H	C98034	\$34.62	C98134	\$29.11
M3.5x0.6 3FLT 6H	C98035	\$31.91	C98135	\$26.81
M4x0.7 3FLT 6H	C98036	\$32.33	C98136	\$26.81
M5x0.8 3FLT 6H	C98037	\$32.33	C98137	\$26.81
M6x1.0 3FLT 6H	C98038	\$32.33	C98138	\$26.81
M7x1.0 3FLT 6H	C98039	\$37.23	C98139	\$27.61
M8x1.0 3FLT 6H	C98040	\$37.23	C98140	\$27.61
M8x1.25 3FLT 6H	C98041	\$37.23	C98141	\$27.61
M10x1.25 3FLT 6H	C98042	\$46.18	C98142	\$26.51
M10x1.5 3FLT 6H	C98043	\$46.18	C98143	\$26.51
M12x1.25 3FLT 6H	C98044	\$54.53	C98144	\$29.86
M12x1.75 3FLT 6H	C98045	\$54.53	C98145	\$29.86
M14x1.5 3FLT 6H	C98046	\$81.05	C98146	\$51.42
M14x2.0 3FLT 6H	C98047	\$81.05	C98147	\$51.42
M16x1.5 4FLT 6H	C98048	\$102.49	C98148	\$71.65
M16x2.0 4FLT 6H	C98049	\$102.49	C98149	\$71.65
M18x1.5 4FLT 6H	C98050	\$142.31	C98150	\$117.13
M18x2.5 4FLT 6H	C98051	\$142.31	C98151	\$117.13
M20x2.5 4FLT 6H	C98052	\$188.97	C98152	\$155.22
M22x2.5 4FLT 6H	C98053	\$208.13	C98153	\$169.51
M24x3.0 4FLT 6H	C98054	\$271.93	C98154	\$229.82



Summer 2024
Promotions

Celebrating 50 Years in Business

----- 1974-2024 -----



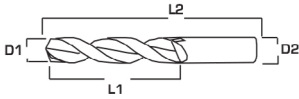

D1 - Cutting Diameter • L1 - Cutting Length
D2 - Shank Diameter • L2 - Overall Length

UNCOATED

Wire	D1	L1	D2	L2	2 Flute	Sale Price
#70	0.0280	5/16	0.0280	1-1/4	163-601-002*	\$14.07
#69	0.0292	5/16	0.0292	1-1/4	163-601-004*	\$13.91
#68	0.0310	5/16	0.0310	1-1/4	163-601-006*	\$13.71
~	1/32	5/16	1/32	1-1/4	163-601-008*	\$10.49
#67	0.0320	5/16	0.0320	1-1/4	163-601-010*	\$13.55
#66	0.0330	5/16	0.0330	1-1/4	163-601-012*	\$13.35
#65	0.0350	5/8	0.0350	1-1/2	163-601-014*	\$13.17
#64	0.0360	5/8	0.0360	1-1/2	163-601-016*	\$12.98
#63	0.0370	5/8	0.0370	1-1/2	163-601-018*	\$12.71
#62	0.0380	5/8	0.0380	1-1/2	163-601-020*	\$12.50
#61	0.0390	5/8	0.0390	1-1/2	163-601-022*	\$12.41
~	0.0394	5/8	0.0394	1-1/2	163-601-024*	\$14.40
#60	0.0400	3/4	0.0400	1-1/2	163-601-026*	\$12.20
#59	0.0410	3/4	0.0410	1-1/2	163-601-028*	\$12.20
#58	0.0420	3/4	0.0420	1-1/2	163-601-030*	\$12.20
#57	0.0430	3/4	0.0430	1-1/2	163-601-032*	\$12.20
#56	0.0465	3/4	0.0465	1-1/2	163-601-034*	\$12.20
~	3/64	3/4	3/64	1-1/2	163-601-036*	\$12.20
#55	0.0520	3/4	0.0520	1-1/2	163-601-038*	\$12.20
#54	0.0550	3/4	0.0550	1-1/2	163-601-040*	\$12.35
~	0.0591	3/4	0.0591	1-1/2	163-601-042*	\$14.55
#53	0.0595	3/4	0.0595	1-1/2	163-601-044*	\$12.35
~	1/16	3/4	1/16	1-1/2	163-601-046	\$12.35
#52	0.0635	3/4	0.0635	1-1/2	163-601-048	\$12.35
#51	0.0670	3/4	0.0670	1-1/2	163-601-050	\$12.35
#50	0.0700	7/8	0.0700	1-3/4	163-601-052	\$12.45
#49	0.0730	7/8	0.0730	1-3/4	163-601-054	\$12.50
#48	0.0760	7/8	0.0760	1-3/4	163-601-056	\$13.07
~	5/64	7/8	5/64	1-3/4	163-601-058	\$13.07
#47	0.0785	7/8	0.0785	1-3/4	163-601-060	\$13.07
~	0.0787	7/8	0.0787	1-3/4	163-601-062	\$15.44
#46	0.0810	7/8	0.0810	1-3/4	163-601-064	\$13.07
#45	0.0820	7/8	0.0820	1-3/4	163-601-066	\$13.35
#44	0.0860	1	0.0860	2	163-601-068	\$13.71
#43	0.0890	1	0.0890	2	163-601-070	\$13.71
#42	0.0935	1	0.0935	2	163-601-072	\$14.03
~	3/32	1	3/32	2	163-601-074	\$14.61
#41	0.0960	1	0.0960	2	163-601-076	\$14.13
#40	0.0980	1	0.0980	2	163-601-078	\$14.55
~	0.0984	1	0.0984	2	163-601-080	\$14.55
#39	0.0995	1-1/4	0.0995	2-1/4	163-601-082	\$14.79
#38	0.1015	1-1/4	0.1015	2-1/4	163-601-084	\$15.33
#37	0.1040	1-1/4	0.1040	2-1/4	163-601-086	\$15.33
#36	0.1065	1-1/4	0.1065	2-1/4	163-601-088	\$15.33
~	7/64	1-1/4	7/64	2-1/4	163-601-090	\$15.98
#35	0.1100	1-1/4	0.1100	2-1/4	163-601-092	\$15.53
#34	0.1110	1-1/4	0.1110	2-1/4	163-601-094	\$16.05
#33	0.1130	1-1/4	0.1130	2-1/4	163-601-096	\$16.05
#32	0.1160	1-1/4	0.1160	2-1/4	163-601-098	\$16.34
~	0.1181	1-1/4	0.1181	2-1/4	163-601-100	\$11.87

* 135° Point

SOLID CARBIDE JOBBER DRILLS

2 Flute - 118° Four Facet Point

Consider PowerA coatings to run more aggressive speeds and feeds!

ALSO AVAILABLE IN:
POWERA
APPEND "1" TO THE PART NUMBER FOR POWERA

Harder than our original TiAlN by 1000 HV and with an increase in thermal stability of 200°F (100°C), PowerA will ensure that heat buildup, friction, and edge breakdown are all greatly reduced, resulting in better cutting performance and longer tool life.

PowerA continues to be the coating of choice for tough-to-cut materials.

- * Hardness: 3800 HV
- * Coating Thickness: 2-4 Microns
- * Thermal Stability: 1,650°F or 900°C



Cutting Edge Tolerance/Shank Tolerance
±.000 - .0002

UNCOATED

Wire	D1	L1	D2	L2	2 Flute	Sale Price
#31	0.1200	1-1/4	0.1200	2-1/4	163-601-102	\$12.23
~	1/8	1-1/4	1/8	2-1/4	163-601-104	\$11.03
#30	0.1285	1-3/8	0.1285	2-1/2	163-601-106	\$11.64
#29	0.1360	1-3/8	0.1360	2-1/2	163-601-108	\$12.12
~	0.1378	1-3/8	0.1378	2-1/2	163-601-110	\$12.12
#28	0.1405	1-3/8	0.1405	2-1/2	163-601-112	\$12.12
~	9/64	1-3/8	9/64	2-1/2	163-601-114	\$12.12
#27	0.1440	1-3/8	0.1440	2-1/2	163-601-116	\$13.91
#26	0.1470	1-3/8	0.1470	2-1/2	163-601-118	\$13.91
#25	0.1495	1-3/8	0.1495	2-1/2	163-601-120	\$13.91
#24	0.1520	1-3/8	0.1520	2-1/2	163-601-122	\$13.91
#23	0.1540	1-3/8	0.1540	2-1/2	163-601-124	\$13.91
~	5/32	1-3/8	5/32	2-1/2	163-601-126	\$13.32
#22	0.1570	1-3/8	0.1570	2-1/2	163-601-128	\$16.43
~	0.1575	1-3/8	0.1575	2-1/2	163-601-130	\$16.43
#21	0.1590	1-3/8	0.1590	2-1/2	163-601-132	\$16.43
#20	0.1610	1-3/8	0.1610	2-1/2	163-601-134	\$16.43
#19	0.1660	1-5/8	0.1660	2-3/4	163-601-136	\$16.43
#18	0.1695	1-5/8	0.1695	2-3/4	163-601-138	\$16.43
~	11/64	1-5/8	11/64	2-3/4	163-601-140	\$16.43
#17	0.1730	1-5/8	0.1730	2-3/4	163-601-142	\$16.76
#16	0.1770	1-5/8	0.1770	2-3/4	163-601-144	\$16.76
~	0.1772	1-5/8	0.1772	2-3/4	163-601-146	\$16.76
#15	0.1800	1-5/8	0.1800	2-3/4	163-601-148	\$16.76
#14	0.1820	1-5/8	0.1820	2-3/4	163-601-150	\$16.76
#13	0.1850	1-5/8	0.1850	2-3/4	163-601-152	\$16.76
~	3/16	1-5/8	3/16	2-3/4	163-601-154	\$16.16
#12	0.1890	1-5/8	0.1890	2-3/4	163-601-156	\$17.63
#11	0.1910	1-5/8	0.1910	2-3/4	163-601-158	\$17.63
#10	0.1935	1-5/8	0.1935	2-3/4	163-601-160	\$17.63
#9	0.1960	1-3/4	0.1960	3	163-601-162	\$17.63
~	0.1968	1-3/4	0.1968	3	163-601-164	\$17.63
#8	0.1990	1-3/4	0.1990	3	163-601-166	\$17.63
#7	0.2010	1-3/4	0.2010	3	163-601-168	\$17.63
~	13/64	1-3/4	13/64	3	163-601-170	\$18.29
#6	0.2040	1-3/4	0.2040	3	163-601-172	\$20.84
#5	0.2055	1-3/4	0.2055	3	163-601-174	\$20.84
#4	0.2090	1-3/4	0.2090	3	163-601-176	\$20.84
#3	0.2130	1-3/4	0.2130	3	163-601-178	\$20.84
~	0.2165	1-3/4	0.2165	3	163-601-180	\$20.84
~	7/32	1-3/4	7/32	3	163-601-182	\$20.84
#2	0.2210	1-3/4	0.2210	3	163-601-184	\$22.52
#1	0.2280	1-3/4	0.2280	3	163-601-186	\$22.52
A	0.2340	2	0.2340	3-1/4	163-601-188	\$22.52
~	15/64	2	15/64	3-1/4	163-601-190	\$22.52
~	0.2362	2	0.2362	3-1/4	163-601-192	\$25.16
B	0.2380	2	0.2380	3-1/4	163-601-194	\$25.16
C	0.2420	2	0.2420	3-1/4	163-601-196	\$25.16
D	0.2460	2	0.2460	3-1/4	163-601-198	\$25.16
E	1/4	2	1/4	3-1/4	163-601-200	\$23.51

Wire	D1	L1	D2	L2	2 Flute	Sale Price
~	0.2559	2	0.2559	3-1/4	163-601-202	\$27.92
F	0.2570	2	0.2570	3-1/4	163-601-204	\$27.92
G	0.2610	2-1/8	0.2610	3-1/2	163-601-206	\$27.92
~	17/64	2-1/8	17/64	3-1/2	163-601-208	\$26.46
H	0.2660	2-1/8	0.2660	3-1/2	163-601-210	\$29.66
I	0.2720	2-1/8	0.2720	3-1/2	163-601-212	\$30.44
~	0.2756	2-1/8	0.2756	3-1/2	163-601-214	\$30.44
J	0.2770	2-1/8	0.2770	3-1/2	163-601-216	\$30.44
K	0.2810	2-1/8	0.2810	3-1/2	163-601-218	\$30.44
~	9/32	2-1/8	9/32	3-1/2	163-601-220	\$29.25
L	0.2900	2-1/8	0.2900	3-1/2	163-601-222	\$34.74
M	0.2950	2-3/8	0.2950	4	163-601-224	\$34.74
~	0.2953	2-3/8	0.2953	4	163-601-226	\$34.74
~	19/64	2-3/8	19/64	4	163-601-228	\$31.59
N	0.3020	2-3/8	0.3020	4	163-601-230	\$35.09
~	5/16	2-3/8	5/16	4	163-601-232	\$31.92
~	0.3150	2-3/8	0.3150	4	163-601-234	\$37.58
O	0.3160	2-3/8	0.3160	4	163-601-236	\$38.58
P	0.3230	2-3/8	0.3230	4	163-601-238	\$38.58
~	21/64	2-3/8	21/64	4	163-601-240	\$36.56
Q	0.3320	2-3/8	0.3320	4	163-601-242	\$41.69
~	0.3346	2-3/8	0.3346	4	163-601-244	\$41.69
R	0.3390	2-3/8	0.3390	4	163-601-246	\$41.69
~	11/32	2-3/8	11/32	4	163-601-248	\$37.76
S	0.3480	2-3/8	0.3480	4	163-601-250	\$46.47
~	0.3543	2-3/4	0.3543	4-1/4	163-601-252	\$46.47
T	0.3580	2-3/4	0.3580	4-1/4	163-601-254	\$46.47
~	23/64	2-3/4	23/64	4-1/4	163-601-256	\$43.46
U	0.3680	2-3/4	0.3680	4-1/4	163-601-258	\$47.78
~	0.3740	2-3/4	0.3740	4-1/4	163-601-260	\$47.78

Wire	D1	L1	D2	L2	2 Flute	Sale Price
~	3/8	2-3/4	3/8	4-1/4	163-601-262	\$43.31
V	0.3770	2-3/4	0.3770	4-1/4	163-601-264	\$55.56
W	0.3860	2-7/8	0.3860	4-1/2	163-601-266	\$55.56
~	25/64	2-7/8	25/64	4-1/2	163-601-268	\$52.65
~	0.3937	2-7/8	0.3937	4-1/2	163-601-270	\$61.58
X	0.3970	2-7/8	0.3970	4-1/2	163-601-272	\$61.58
Y	0.4040	2-7/8	0.4040	4-1/2	163-601-274	\$61.58
~	13/32	2-7/8	13/32	4-1/2	163-601-276	\$56.09
Z	0.4130	2-7/8	0.4130	4-1/2	163-601-278	\$73.50
~	0.4134	2-7/8	0.4134	4-1/2	163-601-280	\$66.57
~	27/64	2-7/8	27/64	4-1/2	163-601-282	\$66.57
~	0.4331	2-7/8	0.4331	4-1/2	163-601-284	\$78.66
~	7/16	2-7/8	7/16	4-1/2	163-601-286	\$64.80
~	0.4527	3	0.4527	4-3/4	163-601-288	\$81.32
~	29/64	3	29/64	4-3/4	163-601-290	\$81.32
~	15/32	3	15/32	4-3/4	163-601-292	\$77.39
~	0.4724	3	0.4724	4-3/4	163-601-294	\$91.20
~	31/64	3	31/64	4-3/4	163-601-296	\$91.20
~	0.4921	3	0.4921	4-3/4	163-601-298	\$92.46
~	1/2	3	1/2	4-3/4	163-601-300	\$84.33
~	17/32	4	17/32	6	163-601-302	\$140.58
~	9/16	4	9/16	6	163-601-304	\$155.31
~	19/32	4	19/32	6	163-601-306	\$172.32
~	5/8	4	5/8	6	163-601-308	\$180.41
~	21/32	4	21/32	6	163-601-310	\$198.66
~	11/16	4	11/16	6	163-601-312	\$204.86
~	23/32	4	23/32	6	163-601-314	\$224.27
~	3/4	4	3/4	6	163-601-316	\$243.92
~	7/8	4	7/8	6	163-601-320	\$286.08
~	1	4	1	6	163-601-322	\$305.99



- The variable 4 flute design interrupts harmonic vibrations to provide improved feeds and speeds, superior finishes and longer tool life.
- Ideal for roughing to finishing operations, in both peripheral and slotting functions.
- Available in our proprietary and proven PowerA (AlTiN) and the optional nanocomposite PowerNR (nACRo) for difficult-to-machine alloys.

V4 Square End - 4 Flute - Variable Helix

Diameter	Length of Cut	Shank Diameter	Overall Length	PowerA			
				No Flat	Price	With Flat	Price
1/4	5/8	1/4	2-1/2	400-010-1	\$24.06	400-010W-1	\$25.27
3/8	7/8	3/8	2-1/2	400-016-1	\$38.44	400-016W-1	\$40.37
1/2	1	1/2	3	400-022-1	\$59.29	400-022W-1	\$62.24
5/8	1-1/4	5/8	3-1/2	400-028-1	\$111.64	400-028W-1	\$117.20
3/4	1-1/2	3/4	4	400-030-1	\$161.75	400-030W-1	\$169.81

V4 Corner Radius - 4 Flute - Variable Helix

Diameter	Length of Cut	Shank Diameter	Overall Length	Radius	PowerA			
					No Flat	Price	With Flat	Price
1/4	5/8	1/4	2-1/2	0.020	400-422-1	\$26.20	400-422W-1	\$27.52
3/8	7/8	3/8	2-1/2	0.020	400-442-1	\$41.62	400-442W-1	\$43.70
1/2	1	1/2	3	0.030	400-463-1	\$61.53	400-463W-1	\$64.57
5/8	1-1/4	5/8	3-1/2	0.030	400-493-1	\$119.46	400-493W-1	\$125.45
3/4	1-1/2	3/4	4	0.030	400-503-1	\$175.32	400-503W-1	\$184.11



Summer 2024 Promotions

Celebrating 50 Years in Business
----- 1974-2024 -----





- An impressive combination of variable flutes, a thicker core and eccentrically-ground relief, adding to performance and value.
- A strong, stable performer sure to provide chatter-free finishes AND aggressive material removal rates.
- Available in PowerA (AlTiN) and nanocomposite PowerNR (nACRo) where tool-life demands the very finest coating available.

V5 Square End - 5 Flute - Variable Helix

Diameter	Length of Cut	Shank Diameter	Overall Length	PowerA			
				No Flat	Price	With Flat	Price
3/8	7/8	3/8	2-1/2	408-010-1	\$41.32	408-010W-1	\$43.40
1/2	1	1/2	3	408-014-1	\$63.73	408-014W-1	\$66.93
5/8	1-1/4	5/8	3-1/2	408-020-1	\$120.01	408-020W-1	\$126.00
3/4	1-1/2	3/4	4	408-024-1	\$173.87	408-024W-1	\$182.57
1	1-1/2	1	4	408-026-1	\$268.65	408-026W-1	\$282.08



V5 Corner Radius - 5 Flute - Variable Helix

Diameter	Length of Cut	Shank Diameter	Overall Length	Radius	PowerA			
					No Flat	Price	With Flat	Price
3/8	7/8	3/8	2-1/2	0.020	408-442-1	\$44.74	408-442W-1	\$46.98
1/2	1	1/2	3	0.030	408-463-1	\$66.11	408-463W-1	\$69.44
5/8	1-1/4	5/8	3-1/2	0.030	408-493-1	\$134.77	408-493W-1	\$141.50
3/4	1-1/2	3/4	4	0.030	408-503-1	\$188.49	408-503W-1	\$197.92
1	1-1/2	1	4	0.030	408-523-1	\$287.25	408-523W-1	\$301.59



High performance non centre cutting design for high efficiency (HEM) in a broad range of work materials including Titanium alloys.

OD D1	LOC L1	SHK D2	OAL L2	Square	Stock	Price	.015 Corner Radius		.030 Corner Radius			
							Stock	Price	Stock	Price		
1/4	3/4	1/4	2-1/2	449-006-8	●	\$30.16	449-421-8	●	\$32.85	449-423-8	○	\$32.85
	1	1/4	3	449-008-8	●	\$43.28	449-431-8	●	\$45.57	449-433-8	○	\$45.57
	1-1/4	1/4	3	449-010-8	●	\$45.91	449-441-8	●	\$48.36	449-443-8	○	\$48.36
5/16	3/4	5/16	2-1/2	449-014-8	●	\$38.86	449-461-8	●	\$42.19	449-463-8	○	\$42.19
	1	5/16	3	449-016-8	●	\$61.37	449-471-8	●	\$68.20	449-473-8	○	\$68.20
3/8	3/4	3/8	2-1/2	449-020-8	●	\$48.17	449-491-8	●	\$52.15	449-493-8	○	\$52.15
	1	3/8	2-1/2	449-022-8	●	\$50.59	449-501-8	●	\$54.78	449-503-8	○	\$54.78
	1-1/2	3/8	3-1/2	449-024-8	●	\$85.73	449-511-8	●	\$97.98	449-513-8	○	\$97.98
	2	3/8	4	449-026-8	●	\$89.62	449-521-8	●	\$102.42	449-523-8	○	\$102.42
1/2	1	1/2	3	449-030-8	●	\$74.31	449-541-8	○	\$77.10	449-543-8	●	\$77.10
	1-1/4	1/2	3	449-032-8	●	\$78.44	449-551-8	○	\$86.50	449-553-8	●	\$86.50
	1-5/8	1/2	4	449-034-8	●	\$101.81	449-561-8	○	\$123.62	449-563-8	●	\$123.62
	2	1/2	4	449-036-8	●	\$110.68	449-571-8	○	\$134.34	449-573-8	●	\$134.34
	2-1/2	1/2	5	449-038-8	●	\$132.81	449-581-8	○	\$161.24	449-583-8	●	\$161.24
5/8	3-1/8	1/2	6	449-040-8	●	\$154.93	449-591-8	○	\$188.10	449-593-8	●	\$188.10
	1-1/4	5/8	3-1/2	449-044-8	●	\$139.93	449-611-8	○	\$149.76	449-613-8	●	\$149.76
	1-5/8	5/8	4	449-046-8	●	\$153.91	449-621-8	○	\$164.73	449-623-8	●	\$164.73
	2-1/8	5/8	4	449-048-8	●	\$206.39	449-631-8	○	\$217.24	449-633-8	●	\$217.24
3/4	1	3/4	3	449-050-8	●	\$184.19	449-641-8	○	\$195.78	449-643-8	●	\$195.78
	1-5/8	3/4	4	449-054-8	●	\$220.46	449-661-8	○	\$235.16	449-663-8	●	\$235.16
	2-1/4	3/4	5	449-056-8	●	\$287.92	449-671-8	○	\$301.60	449-673-8	●	\$301.60
	3-1/4	3/4	6	449-058-8	●	\$345.16	449-681-8	○	\$361.93	449-683-8	●	\$361.93



● Caliber Stock
○ Factory Order















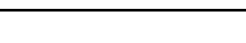

















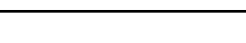











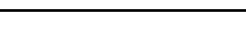

Summer 2024 Promotions

Celebrating 50 Years in Business

----- 1974-2024 -----



Tool Guide	Item #	Shape	Diam.	Cut Type	OAL	Price
	163-SB-1DC	Cylindrical with End Cut	1/4"	Doublecut	2"	\$10.95
	163-SB-3DC	Cylindrical with End Cut	3/8"	Doublecut	2-1/2"	\$15.10
	163-SB-3FM	Cylindrical with End Cut	3/8"	Alumacut	2-1/2"	\$19.47
	163-SB-3L6DC	Cylindrical with End Cut	3/8"	Doublecut	6-3/4"	\$23.41
	163-SB-5DC	Cylindrical with End Cut	1/2"	Doublecut	2-3/4"	\$24.06
	163-SB-5FM	Cylindrical with End Cut	1/2"	Alumacut	2-3/4"	\$30.92
	163-SB-5L6DC	Cylindrical with End Cut	1/2"	Doublecut	7"	\$32.39
	163-SC-1DC	Radius Cylindrical	1/4"	Doublecut	2"	\$11.56
	163-SC-3DC	Radius Cylindrical	3/8"	Doublecut	2-1/2"	\$15.28
	163-SC-3L6DC	Radius Cylindrical	3/8"	Doublecut	6-3/4"	\$23.61
	163-SC-5DC	Radius Cylindrical	1/2"	Doublecut	2-3/4"	\$24.06
	163-SC-5FM	Radius Cylindrical	1/2"	Alumacut	2-3/4"	\$30.92
	163-SC-5L6DC	Radius Cylindrical	1/2"	Doublecut	7"	\$32.39
	163-SD-1DC	Ball	1/4"	Doublecut	2"	\$11.16
	163-SD-3DC	Ball	3/8"	Doublecut	2-1/8"	\$13.65
	163-SD-5DC	Ball	1/2"	Doublecut	2-1/4"	\$17.50
	163-SD-5FM	Ball	1/2"	Alumacut	2-1/4"	\$22.48
	163-SD-5L6DC	Ball	1/2"	Doublecut	6-1/2"	\$25.83
	163-SE-1DC	Oval	1/4"	Doublecut	2"	\$13.74
	163-SE-3DC	Oval	3/8"	Doublecut	2-3/8"	\$16.98
	163-SE-5DC	Oval	1/2"	Doublecut	2-5/8"	\$24.06
	163-SE-5L6DC	Oval	1/2"	Doublecut	6-7/8"	\$32.39
	163-SF-3DC	Radius Tree	3/8"	Doublecut	2-1/2"	\$15.72
	163-SF-3FM	Radius Tree	3/8"	Alumacut	2-1/2"	\$20.30
	163-SF-3L6DC	Radius Tree	3/8"	Doublecut	6-3/4"	\$24.06
	163-SF-3L6FM	Radius Tree	3/8"	Alumacut	6-3/4"	\$28.62
	163-SF-5DC	Radius Tree	1/2"	Doublecut	2-3/4"	\$22.26
	163-SF-5FM	Radius Tree	1/2"	Alumacut	2-3/4"	\$28.73
	163-SF-5L6DC	Radius Tree	1/2"	Doublecut	7"	\$30.59
	163-SF-5L6FM	Radius Tree	1/2"	Alumacut	7"	\$37.04
	163-SG-1DC	Pointed Tree	1/4"	Doublecut	2"	\$12.49
	163-SG-3DC	Pointed Tree	3/8"	Doublecut	2-1/2"	\$15.72
	163-SG-3L6DC	Pointed Tree	3/8"	Doublecut	6-3/4"	\$24.06
	163-SG-5DC	Pointed Tree	1/2"	Doublecut	2-3/4"	\$22.26
	163-SG-5L6DC	Pointed Tree	1/2"	Doublecut	7"	\$30.59
	163-SH-5DC	Flame	1/2"	Doublecut	3"	\$31.45
	163-SJ-3DC	60° Included Cone	3/8"	Doublecut	2-1/16"	\$13.95
	163-SJ-5DC	60° Included Cone	1/2"	Doublecut	2-3/16"	\$17.28
	163-SK-3DC	90° Included Cone	3/8"	Doublecut	1-15/16"	\$13.95
	163-SK-5DC	90° Included Cone	1/2"	Doublecut	2"	\$17.28
	163-SL-3DC	14° Radius Cone	3/8"	Doublecut	2-13/16"	\$19.07
	163-SL-3FM	14° Radius Cone	3/8"	Alumacut	2-13/16"	\$24.45
	163-SL-3L6DC	14° Radius Cone	3/8"	Doublecut	7-1/16"	\$27.38
	163-SL-4DC	14° Radius Cone	1/2"	Doublecut	3-1/64"	\$24.25
	163-SL-4FM	14° Radius Cone	1/2"	Alumacut	3-1/64"	\$31.20
	163-SL-4L6DC	14° Radius Cone	1/2"	Doublecut	7-1/8"	\$32.59
	163-SL-4L6FM	14° Radius Cone	1/2"	Alumacut	7-1/8"	\$39.55
	163-SM-2DC	14° Pointed Cone	1/4"	Doublecut	2"	\$13.11
	163-SM-4DC	14° Pointed Cone	3/8"	Doublecut	2-1/2"	\$18.73
	163-SM-5DC	14° Pointed Cone	1/2"	Doublecut	2-5/8"	\$24.06
	163-SM-5L6DC	14° Pointed Cone	1/2"	Doublecut	6-7/8"	\$32.39
	163-SN-2DC	13° Inverted Cone	3/8"	Doublecut	2-1/8"	\$21.45



Power Pouch Bur Sets

All tools in these sets are 1/4" diameter shank Alumacuts recommended for non-ferrous materials

- 163-POUCH-WL2DC
SC-5, SC-3, SF-5, SF-3 (4pc.)
Doublecut
PRICE: \$81.64
- 163-POUCH-WL2FM
SC-5, SC-3, SF-5, SF-3 (4pc.)
Alumacut
PRICE: \$103.90
- 163-POUCH-WL3DC
SA-1, SC-3, SF-3, SC-5, SF-5 (5pc.)
Doublecut
PRICE: \$91.72
- 163-POUCH-WL3FM
SA-1, SC-3, SF-3, SC-5, SF-5 (5pc.)
Alumacut
PRICE: \$116.92



253-MPT3030 PROFESSIONAL CHOICE

- 1/4" mini
 - Low profile
 - 19,000 RPM
 - 0.7 lb
 - 0.25 HP **\$149.00**
- 

253-MPT1020 INDUSTRIAL ASSEMBLY

- 1/4" mini
 - 25,000 RPM
 - 0.3 HP
 - 0.7 lb **\$83.00**
- 



BUY BOTH IN ONE CASE!
\$190.00

253-MPT3039



Summer 2024 Promotions

Celebrating 50 Years in Business
----- 1974-2024 -----



ata Karnasch®

Countersink Sets

HSS-XE Steel

Made of high-alloyed special steel «XE» for considerably longer service life than HSS-Steel.

- Stainless steel V2A
- Steel
- Cast iron
- Non ferrous material

HSS-XE Steel + BLUE-TEC Coating

Made of high-alloyed special steel "XE" with BLUE-TEC coating for a substantial increase in service life also when machining dry (no/little cooling).

- High-alloyed chromium steel such as stainless (V2A/V4A)
- Acid resistant steel
- Steel
- Cast Iron
- Non ferrous metals



45% OFF

TAPER AND DEBURRING COUNTERSINKS
TYPE C 82° 3-flat shank



45% OFF

TAPER AND DEBURRING COUNTERSINKS
DIN 335 TYPE C 90° 3-flat shank



20.1695
82°
20.1696

Ø 1/4", 5/16", 3/8", 1/2", 5/8", 3/4"

List: \$276.56 **SALE 152¹¹\$**

Ø 1/4", 3/8", 5/8", 3/4", 1"

List: \$276.56 **SALE 152¹¹\$**

20.1641
90°
20.1642

Ø 6,3 · 8,3 · 10,4 · 12,4 · 16,5 · 20,5 mm

List: \$289.09 **SALE 159⁰⁰\$**

Ø 6,3 · 10,4 · 16,5 · 20,5 · 25 mm

List: \$289.09 **SALE 159⁰⁰\$**

HSS-XE



20.1697
82°
20.1698

Ø 1/4", 5/16", 3/8", 1/2", 5/8", 3/4"

List: \$435.11 **SALE 239³¹\$**

Ø 1/4", 3/8", 5/8", 3/4", 1"

List: \$416.68 **SALE 229¹⁷\$**

20.1643
90°
20.1644

Ø 6,3 · 8,3 · 10,4 · 12,4 · 16,5 · 20,5 mm

List: \$431.43 **SALE 237²⁹\$**

Ø 6,3 · 10,4 · 16,5 · 20,5 · 25 mm

List: \$409.30 **SALE 225¹²\$**

HSS-XE + BLUE-TEC



Power. Precision. Performance.

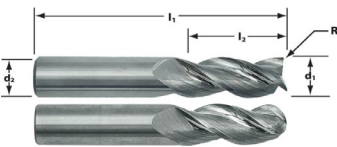

M213 STREAKERS

d1: -0.0001 / -0.0004 d2: -0.0001 / -0.0004
cr/ball nose: + / - 0.0015



Cutter Dia d1	Shank Dia d2	Length of Cut l2	Overall Length l1	Order Code SQ	PRICE	.015 CR	.031 CR	PRICE
1/8	1/8	3/8	2	64556	\$23.79	64557	-	\$23.97
3/16	3/16	5/8	2-1/2	64567	\$27.23	64568	-	\$28.36
1/4	1/4	3/4	2-1/2	64583	\$34.17	64584	-	\$38.46
5/16	5/16	13/16	2-1/2	64596	\$38.82	64597	-	\$41.90
3/8	3/8	1	2-1/2	64612	\$43.81	64613	-	\$48.37
1/2	1/2	1-1/4	3	64643	\$69.25	64644	64645	\$72.84
5/8	5/8	1-5/8	4	64673	\$149.89	-	64675	\$168.71
3/4	3/4	1-5/8	4	64691	\$190.82	-	64692	\$211.39



Summer 2024 Promotions

Celebrating 50 Years in Business

----- 1974-2024 -----



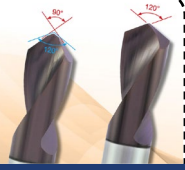

DTN - FOR SPOTTING · EXTERNAL COOLANT · TIP ANGLE 90° & 120° · DOUBLE ANGLE TIP

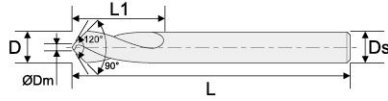

- 90° Tip Angle
- 45° Chamfer Angle
- External Coolant
- UNIX Coating
- Tolerance h8
- 90° & 120° double angle tip design, reduces drill tip cracking

P	M	K	N	S	H
●	●	●	○	●	●

Unit: mm

Order No.	ØDm	D	L1	L	Ds	PRICE
336-DTN01300901	0.3	1.30	4	50	3	\$14.93
336-DTN01700901	0.4	1.70	5	50	3	\$14.93
336-DTN03000901	0.8	3.00	8	50	3	\$14.93
336-DTN04000901	1.0	4.00	10	50	4	\$16.86
336-DTN05000901	1.3	5.00	13	50	5	\$18.31
336-DTN06000901	1.5	6.00	15	50	6	\$22.17
336-DTN08000901	2.0	8.00	20	60	8	\$33.74
336-DTN10000901	2.5	10.00	25	75	10	\$64.09
336-DTN12000901	3.0	12.00	30	75	12	\$85.30
336-DTN16000901	4.0	16.00	35	100	16	\$144.08

Order No.	ØDm	D	L1	L	Ds	PRICE
<i>* Long Shank Type</i>						
336-DTN04000911	1.0	4.00	10	75	4	\$22.17
336-DTN05000911	1.3	5.00	13	75	5	\$27.46
336-DTN06000911	1.5	6.00	15	100	6	\$33.25
336-DTN08000911	2.0	8.00	20	100	8	\$51.09
336-DTN10000911	2.5	10.00	25	150	10	\$95.90
336-DTN12000911	3.0	12.00	30	150	12	\$128.18
336-DTN16000911	4.0	16.00	35	150	16	\$205.77

DTN - FOR SPOTTING · EXTERNAL COOLANT · TIP ANGLE 90°

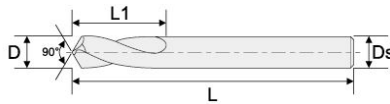

- 90° Tip Angle
- 45° Chamfer Angle
- External Coolant
- UNIX Coating
- Tolerance h8
- 90° single angle tip design

P	M	K	N	S	H
●	●	●	○	○	●

Unit: mm

Order No.	D	L1	L	Ds	PRICE
336-DTN01300951	1.30	4	50	3	\$14.93
336-DTN01700951	1.70	5	50	3	\$14.93
336-DTN03000951	3.00	8	50	3	\$14.93
336-DTN04000951	4.00	10	50	4	\$16.86
336-DTN05000951	5.00	13	50	5	\$18.31
336-DTN06000951	6.00	15	50	6	\$22.17
336-DTN08000951	8.00	20	60	8	\$33.74
336-DTN10000951	10.00	25	75	10	\$64.09
336-DTN12000951	12.00	30	75	12	\$85.30
336-DTN16000951	16.00	35	100	16	\$144.08

Order No.	D	L1	L	Ds	PRICE
<i>* Long Shank Type</i>					
336-DTN04000961	4.00	10	75	4	\$22.17
336-DTN05000961	5.00	13	75	5	\$27.46
336-DTN06000961	6.00	15	100	6	\$33.25
336-DTN08000961	8.00	20	100	8	\$51.09
336-DTN10000961	10.00	25	150	10	\$95.90
336-DTN12000961	12.00	30	150	12	\$128.18
336-DTN16000961	16.00	35	150	16	\$205.77

DTN - FOR SPOTTING · EXTERNAL COOLANT · TIP ANGLE 120°

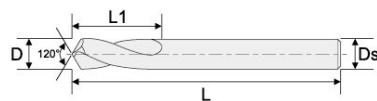

- 120° Tip Angle
- 60° Chamfer Angle
- External Coolant
- UNIX Coating
- Tolerance h8

P	M	K	N	S	H
●	●	●	○	●	●

Unit: mm

Order No.	D	L1	L	Ds	PRICE
336-DTN03001201	3.00	8	50	3	\$14.93
336-DTN04001201	4.00	10	50	4	\$16.86
336-DTN05001201	5.00	13	50	5	\$18.31
336-DTN06001201	6.00	15	50	6	\$22.17
336-DTN08001201	8.00	20	60	8	\$33.74
336-DTN10001201	10.00	25	75	10	\$64.09
336-DTN12001201	12.00	30	75	12	\$85.30
336-DTN16001201	16.00	35	100	16	\$144.08

Order No.	D	L1	L	Ds	PRICE
<i>* Long Shank Type</i>					
336-DTN04001211	4.00	10	75	4	\$22.17
336-DTN05001211	5.00	13	75	5	\$27.46
336-DTN06001211	6.00	15	100	6	\$33.25
336-DTN08001211	8.00	20	100	8	\$51.09
336-DTN10001211	10.00	25	150	10	\$95.90
336-DTN12001211	12.00	30	150	12	\$128.18
336-DTN16001211	16.00	35	150	16	\$198.53





Corner Rounding Cutter

▲PRFRAD ≤ 1.397 [Inch] Tol. = ± 0.01
 ▲PRFRAD > 1.397 [Inch] Tol. = ± 0.015

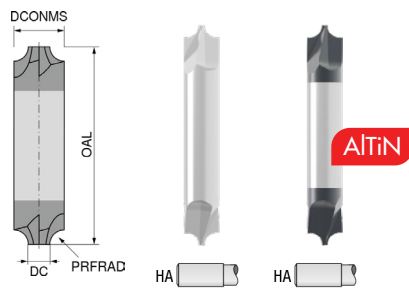

PRFRAD inch	DC +0.000/-0.002 inch	OAL inch	DCONMS -0.0001/-0.0004 inch	ZEFP	59049...	Price	59050...	Price
0.010	0.125	1 1/2	1/8	2	12510	\$36.42	12510	\$41.88
0.015	0.125	1 1/2	1/8	2	12515	\$36.42	12515	\$41.88
0.020	0.125	1 1/2	1/8	2	12520	\$36.42	12520	\$41.88
0.025	0.125	1 1/2	1/8	2	12525	\$36.42	12525	\$41.88
0.031	0.125	1 1/2	1/8	2	12531	\$36.42	12531	\$41.88
0.035	0.125	1 1/2	1/8	2	12535	\$36.42	12535	\$41.88
0.040	0.125	1 1/2	1/8	2	12540	\$36.42	12540	\$41.88
0.046	0.125	1 1/2	1/8	2	12546	\$45.09	12546	\$51.79
0.050	0.188	2	3/16	2	18850	\$45.09	18850	\$51.79
0.055	0.188	2	3/16	2	18855	\$45.09	18855	\$51.79
0.062	0.188	2	3/16	2	18862	\$45.09	18862	\$51.79
0.072	0.250	2 1/2	1/4	2	25072	\$52.87	25072	\$60.88
0.078	0.250	2 1/2	1/4	2	25078	\$52.87	25078	\$60.88
0.085	0.250	2 1/2	1/4	2	25085	\$52.87	25085	\$60.88
0.094	0.250	2 1/2	1/4	2	25094	\$52.87	25094	\$60.88
0.100	0.250	2 1/2	1/4	2	25000	\$52.87	25000	\$60.88
0.109	0.250	2 1/2	1/4	2	25009	\$68.15	25009	\$84.07
0.118	0.313	2 1/2	5/16	2	31318	\$68.15	31318	\$84.07
0.125	0.313	2 1/2	5/16	2	31325	\$68.15	31325	\$84.07
0.140	0.375	2 1/2	3/8	2	37540	\$91.33	37540	\$107.25
0.156	0.375	2 1/2	3/8	2	37556	\$91.33	37556	\$107.25



Corner Rounding Cutter

▲PRFRAD ≤ 1.397 [Inch] Tol. = ± 0.01
 ▲PRFRAD > 1.397 [Inch] Tol. = ± 0.015

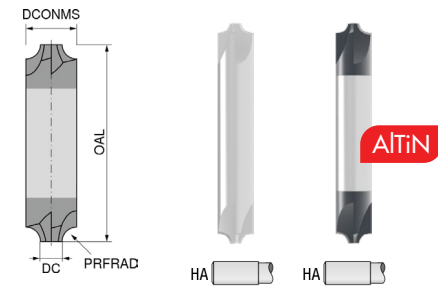

PRFRAD inch	DC +0.000/-0.002 inch	APMX inch	OAL inch	DCONMS -0.0001/-0.0004 inch	ZEFP	59051...	Price	59052...	Price
0.010	3/16	3/16	2	3/16	4	18810	\$45.09	18810	\$56.34
0.015	3/16	3/16	2	3/16	4	18910	\$45.09	18910	\$56.34
0.020	3/16	3/16	2	3/16	4	19010	\$45.09	19010	\$56.34
0.025	3/16	3/16	2	3/16	4	19110	\$45.09	19110	\$56.34
0.031	3/16	3/16	2	3/16	4	19210	\$45.09	19210	\$56.34
0.035	3/16	3/16	2	3/16	4	19310	\$45.09	19310	\$56.34
0.040	1/4	1/4	2 1/2	1/4	4	25010	\$58.52	25010	\$73.13
0.046	1/4	1/4	2 1/2	1/4	4	25110	\$58.52	25110	\$73.13
0.050	1/4	1/4	2 1/2	1/4	4	25210	\$58.52	25210	\$73.13
0.055	1/4	1/4	2 1/2	1/4	4	25410	\$58.52	25410	\$73.13
0.062	1/4	1/4	2 1/2	1/4	4	25310	\$58.52	25310	\$73.13
0.078	3/8	3/8	2 1/2	3/8	4	37510	\$89.29	37510	\$111.61
0.094	3/8	3/8	2 1/2	3/8	4	37610	\$89.29	37610	\$111.61
0.100	3/8	3/8	2 1/2	3/8	4	37710	\$89.29	37710	\$111.61
0.118	3/8	3/8	2 1/2	3/8	4	37810	\$89.29	37810	\$111.61
0.125	3/8	3/8	2 1/2	3/8	4	37910	\$89.29	37910	\$111.61
0.156	1/2	1/2	3	1/2	4	50010	\$112.77	50010	\$141.03



**COOLCUT™
250**

Order# 168-58A257

**Price
\$169.00**



BY FAR

The Best Choice
For Your Band Saw!



◀ SCAN QR Code
To Learn How!

Machining Operations | Grinding | Sawing

EDP#166-E89.700.250
PRICE: \$23.58

**ECONO 897 PASTE
8.8 OZ./250 G**

EDP#166-E89.700.750
PRICE: \$53.89

**ECONO 897 PASTE
26.9 OZ./750 G**

EDP# 166-E89.700.005
PRICE: \$250.46

**ECONO 897 PASTE
11 LBS/5 KG**



Summer 2024
Promotions

Celebrating 50 Years in Business

----- 1974-2024 -----



Eco Run

Positive Turning Inserts

EDP#	Description	Sale Price	Application
340-705353	CCMT 3(2.5)1-PPM P25C	\$7.34	General Steel
340-705383	DCMT 3(2.5)1-PPM P25C	\$8.96	
340-705393	SCMT 3(2.5)1-PPM P25C	\$7.68	
340-705646	TCMT 3(2.5)1-PPM P25C	\$8.69	
340-705832	VBMT 331-PPM P25C	\$12.69	
340-705933	CCMT 3(2.5)1-PMM M25C	\$6.70	Stainless Steel
340-706041	DCMT 3(2.5)1-PMM M25C	\$8.14	
340-706174	SCMT 3(2.5)1-PMM M25C	\$6.99	
340-706270	TCMT 3(2.5)1-PMM M25C	\$7.86	
340-706322	VBMT 331-PMM M25C	\$11.50	

Negative Turning Inserts

EDP#	Description	Sale Price	Application
340-705458	CNMG 432-PM P25C	\$8.69	General Steel
340-705571	DNMG 432-PM P25C	\$12.09	
340-705603	SNMG 432-PM P25C	\$9.12	
340-705665	TNMG 332-PM P25C	\$7.79	
340-705712	VNMG 332-PM P25C	\$10.86	
340-705420	WNMG 432-PM P25C	\$9.51	Stainless Steel
340-706867	CNMG 432-MM1 M25C	\$8.69	
340-707521	DNMG 432-MM1 M25C	\$12.09	
340-705249	SNMG 432-MM M25C	\$8.30	
340-707694	TNMG 332-MM1 M25C	\$7.79	
340-706674	VNMG 332-MM1 M25P	\$11.45	
340-706878	WNMG 432-MM1 M25C	\$9.51	

SHAVIV USA by Vargus

Leading Deburring Solutions

DEBURRING TOOL



Handle	Order #	PRICE
Set B	140-29065	\$17.37
Set E	140-29069	\$20.28

10+2 Blades Bonus Pack

Blade	Order #	PRICE
B10	140-26262	\$14.49
B20	140-29269	\$18.72
E100	140-26270	\$16.49
E200	140-29271	\$18.72
E100P	140-29258	\$33.60

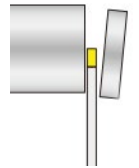
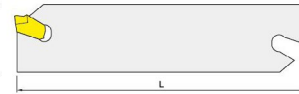
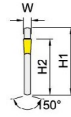

Order No.	Designation	Working Material					
		P	M	K	N	S	H
ITGTN031032HS	TGTN0310-CX32HS	●	●	●		○	○
ITGTN041032HS	TGTN0410-CX32HS	●	●	●		○	○

Caliber EDP#	Blade Height	Height to Cutting Edge	Blade Length	Insert Width	Insert Radius	Kit Price (ea)
336-ISGIH263	26mm	21.4mm	110mm	3.1mm	0.2mm	\$104.37
C/W 10pcs 336-TGTN0310-CX32HS Inserts + 1pc 336-IESG-1 Wrench						
336-ISGIH323	32mm	25mm	150mm	3.1mm	0.2mm	\$120.75
C/W 10pcs 336-TGTN0310-CX32HS Inserts + 1pc 336-IESG-1 Wrench						
336-ISGIH264	26mm	21.4mm	110mm	4.1mm	0.25mm	\$107.20
C/W 10pcs 336-TGTN0410-CX32HS Inserts + 1pc 336-IESG-1 Wrench						
336-ISGIH324	32mm	25mm	150mm	4.1mm	0.25mm	\$131.18
C/W 10pcs 336-TGTN0410-CX32HS Inserts + 1pc 336-IESG-1 Wrench						

* CX33TS grade for General grooving.



TM Solid

Solid Carbide Thread Milling Tools

15% Off

When purchasing **2** standard **TM Solid** tools of the **same** item

OR

25% Off

When purchasing **4** standard **TM Solid** tools of the **same** item



Eklind

Ball-Hex-L™ Key Combo Pack

Order# 371-13222
Price: \$27.99

**Heat Treated for optimum strength and ductility.
Color coded RED for INCH (Sizes: .050 - 3/8)
Color coded BLUE for METRIC (Sizes: 1.5 - 10)

Summer 2024 Promotions

Celebrating 50 Years in Business

----- 1974-2024 -----



Part #	Description	l1	D	Max. Shank	Stop Screw	Wrench	Nut	PRICE
117-22225	Special Bulk Pricing CAT40 x ER16 - 2.76", hex nut	2.76"	1.08"	.406"	16083	04609	41116	\$91.50
117-22227	CAT40 x ER16 - 4", hex nut	4"	1.08"	.406"	16083	04609	41116	\$92.50
117-22231	CAT40 x ER16 - 6", hex nut	6"	1.08"	.406"	16083	04609	41116	\$164.16
117-22233	CAT40 x ER16 - 8", hex nut	8"	1.08"	.406"	16083	04609	41116	\$183.38
117-22233-10	CAT40 x ER16 - 10", hex nut	10"	1.08"	.406"	16083	04609	41116	\$225.02
117-22253	Special Bulk Pricing CAT40 x ER32 - 2.76", slotted nut	2.76"	1.97"	.788"	16089	04616	41932	\$98.50
117-22255	CAT40 x ER32 - 4", slotted nut	4"	1.97"	.788"	16089	04616	41932	\$98.50
117-22257	CAT40 x ER32 - 6", slotted nut	6"	1.97"	.788"	16089	04616	41932	\$177.78
117-22259	CAT40 x ER32 - 8", slotted nut	8"	1.97"	.788"	16089	04616	41932	\$198.60
117-22259-10	CAT40 x ER32 - 10", slotted nut	10"	1.97"	.788"	16089	04616	41932	\$225.02
117-22281	CAT50 x ER16 - 4", hex nut	4"	1.08"	.406"	16083	04609	41116	\$178.58
117-22285	CAT50 x ER16 - 6", hex nut	6"	1.08"	.406"	16083	04609	41116	\$193.79
117-22287	CAT50 x ER16 - 8", hex nut	8"	1.08"	.406"	16083	04609	41116	\$255.46
117-22287-10T	CAT50 x ER16 - 10", hex nut	10"	1.08"	.406"	16083	04609	41116	\$412.41
117-22287-12T	CAT50 x ER16 - 12", hex nut	12"	1.08"	.406"	16083	04609	41116	\$468.47
117-22311	CAT50 x ER32 - 4", slotted nut	4"	1.97"	.788"	16089	04616	41932	\$173.77
117-22313	CAT50 x ER32 - 6", slotted nut	6"	1.97"	.788"	16089	04616	41932	\$203.40
117-22317	CAT50 x ER32 - 8", slotted nut	8"	1.97"	.788"	16089	04616	41932	\$229.03
117-22317-10T	CAT50 x ER32 - 10", slotted nut	10"	1.97"	.788"	16089	04616	41932	\$412.41
117-22317-12T	CAT50 x ER32 - 12", slotted nut	12"	1.97"	.788"	16089	04616	41932	\$468.47



CAT40 & CAT50 ER COLLET CHUCKS

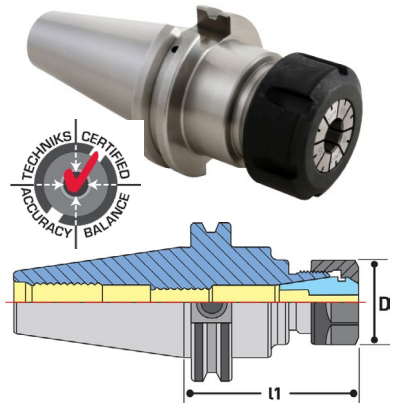

Techniks Certified for accuracy and balance. Each holder comes with a complete lab report. PowerCOAT nut is included with each holder.



- High clamping force 400-700KGf/cm.
- Suitable for high speed running
- Hex Can hold drills, taps and end mills due to high clamping force
- Includes hex key wrench

HEX KEY

KEYLESS



Order Number	Description	Drill Chuck Type	Clamping Range	Price
331-CT40223202A	CAT40XGHK13S-90L	HEX KEY	0,3-13MM	\$299.00
331-CT40224202A	CAT40XGHK16S-95L		1,5-16MM	\$329.00
331-CT50224202A	CAT50XGHK16S-95L		1,5-16MM	\$349.00
331-HK22526	HSK63AXGHK13S-105		0,3-13MM	\$369.00
331-HK22528	HSK63AXGHK16S-110		1,5-16MM	\$389.00
331-BT22518	BT40XGHK13S-98L		0,3-13MM	\$299.00
331-BA2CT40043115A	CAT40 X CHU13-115L(4.53")	KEYLESS	0,3-13MM	\$241.80
331-BA2CT40044120A	CAT40 X CHU16-120L(4.72")		3-16MM	\$288.15

** Complete with wrench **



Order Number	Description	Drill Chuck Type	Clamping Range	Price
240-BT40DC13	BT40 DC13 (1/2") x 100L	KEYLESS DRILL CHUCK-ECO	1-13MM	\$239.00
240-BT40DC16	BT40 DC16 (5/8") x 110L		3-16MM	\$259.00

** Suitable when high precision is **NOT** required **



Partial Profile 60° Threading Inserts

				External	Internal				
L (mm)	I.C.	mm	TPI	Right Hand	Right Hand	Application			
16	3/8"	0.5-3.0	8-48	16ER AG60 BMA	16IR AG60 BMA	P	M	N	\$14.99
16	3/8"	0.5-3.0	8-48	16ER AG60 BLU	16IR AG60 BLU		M		\$14.99

** Versatile, cost-effective thread turning inserts. Each insert is compatible with a range of thread pitches.



Celebrating 50 Years in Business

----- 1974-2024 -----





Single Sets

For those looking for an Economical Start!



SCAN QR CODE
To View
Torque Tool & Screwdriver
Full Catalogue

Torque Screwdriver Single Set for TORX®, 25mm+50mm Bits

Parts No.	Contents						N.W.	Packaging Illustration	Price
	Handle	Adapter			Bit				
		Nm	KgfcM	In-lb	Size	25mm+50mm			
0-TPK01-TX06-0.6-S	TPK-H02	0.6	6.1	5.3	TX6	2 pcs + 2 pcs	122g		\$70.64
0-TPK01-TX07-0.9-S		0.9	9.2	8.0	TX7				\$70.64
0-TPK01-TX08-1.2-S		1.2	12.0	10.6	TX8				\$70.64
0-TPK01-TX08-2.0	TPK-H01	2.0	20.4	17.7	TX8	2 pcs + 2 pcs	130g		\$70.64
0-TPK01-TX09-1.4		1.4	14.0	12.4	TX9				\$70.64
0-TPK01-TX09-2.0		2.0	20.4	17.7	TX9				\$70.64
0-TPK01-TX10-2.0		2.0	20.4	17.7	TX10				\$70.64
0-TPK01-TX15-3.0		3.0	30.6	26.6	TX15				\$70.64
0-TPK01-TX20-5.0		5.0	51.0	44.3	TX20				\$70.64
0-TPK01-TX20-5.5		5.5	56.1	48.7	TX20				\$70.64
0-TPK01-TX2025-5.5	TPK-H03	5.5	56.1	48.7	TX20	Bit 50mm	200g		\$83.17
						2 pcs			
						TX25			

Torque Screwdriver Single Set for TORX PLUS®, 25mm+50mm Bits

Parts No.	Contents						N.W.	Packaging Illustration	Price
	Handle	Adapter			Bit				
		Nm	KgfcM	In-lb	Size	25mm+50mm			
0-TPK02-6IP-0.6-S	TPK-H02-B	0.6	6.1	5.3	6IP	2 pcs + 2 pcs	130g		\$77.40
0-TPK02-7IP-0.9-S		0.9	9.2	8.0	7IP				\$77.40
0-TPK02-8IP-1.2-S		1.2	12.0	10.6	8IP				\$77.40
0-TPK02-9IP-1.4	TPK-H01-B	1.4	14.0	12.4	9IP	2 pcs + 2 pcs	130g		\$77.40
0-TPK02-10IP-2.0		2.0	20.4	17.7	10IP				\$77.40
0-TPK02-15IP-3.0		3.0	30.6	26.6	15IP				\$77.40
0-TPK02-20IP-5.0		5.0	51.0	44.3	20IP				\$77.40
0-TPK02-2025IP-5.5	TPK-H03-B	5.5	56.1	48.7	20IP	Bit 50mm	200g		\$92.75
						2 pcs			
						25IP			



Summer 2024
Promotions

Celebrating 50 Years in Business

----- 1974-2024 -----





FREE CUTTER Yours

with a purchase of
10 inserts/inch



8 Cutting Edges!!

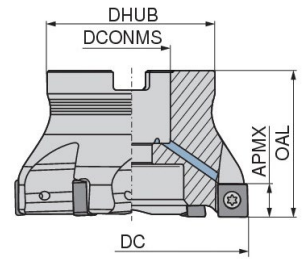

MILLING TOOLS WITH INDEXABLE INSERTS INCH

d ₁	Designation	h	d	d _A	α	z	n _{max} [min ⁻¹]	[Nm]	Insert Type	Milling System
2.00	A491.200.R.04-09-A075-175-EF	1.75	2.00	0.75	.236	4	9800	3.2	SNHU 09T3..	MaxiMill Shell mill A 491-09
2.50	A491.250.R.05-09-A100-200-EF	2.00	2.50	1.00	.236	5	8500	3.2		
3.00	A491.300.R.06-09-A100-200-EF	2.00	3.00	1.00	.236	6	7400	3.2		
4.00	A491.400.R.07-09-A125-200-EF	2.00	4.00	1.25	.236	7	6500	3.2		
2.00	A491.200.R.04-12-A075-175-EF	1.75	2.00	0.75	.312	4	11500	3.2	SNHU 1204..	MaxiMill Shell mill A 491-12
2.50	A491.250.R.05-12-A100-200-EF	2.00	2.50	1.00	.312	5	9800	3.2		
3.00	A491.300.R.06-12-A100-200-EF	2.00	3.00	1.00	.312	6	8500	3.2		
4.00	A491.400.R.07-12-A125-200-EF	2.00	4.00	1.25	.312	7	7400	3.2		

*Other sizes available upon request!

MaxiMill Shell mill A 491-09 APPLICABLE INSERTS		CTCP230	CTPP235	CTPM240	CTCK215	CTPK220	CTWN215	Price
	SNHU 09T308FR-F10						●	\$25.23
	SNHU 09T308SR-F50			●				
	SNHU 09T308SR-M50	●	●	●				

As Low As
\$3.15
Per Edge

MaxiMill Shell mill A 491-12 APPLICABLE INSERTS		CTCP230	CTPP235	CTPM240	CTCK215	CTPK220	CTWN215	Price
	SNHU 120408FR-F10						●	\$30.52
	SNHU 120408SR-F50			●				
	SNHU 120408SR-M50	●	●	●				
	SNHU 120408SR-R50				●	●		

As Low As
\$3.82
Per Edge

Spare Parts

11689894 11696194 8095012000

Spare Parts

11610311 11450867 8095012000

NC HELIX DRILL
The Expert Of Swarfs Control!

SCAN for Promotion Details

Buy **1** HOLDER Get **2** INSERTS **FREE** Same Grade

Swarf Control: Small & Short

Tool Path Tool Rotation

"Ideal for Automation Production, Rough Milling, Drilling & Slotting."



SHOP ROLLS



Order #	Size	Grit	Price (ea)
358-114554	1" x 55 YD	60	\$47.46
358-114555		80	\$41.76
358-114556		100	\$38.44
358-114557		120	\$38.44
358-114558		150	\$38.44
358-114559		180	\$38.44
358-114560		220	\$38.44
358-114561		240	\$38.44
358-114562		320	\$38.44
358-114563		400	\$38.44
358-114638	1-1/2" x 55 YD	80	\$63.52
358-114639		100	\$59.62
358-114640		120	\$59.62
358-114641		150	\$59.62
358-114642		180	\$59.62
358-114643		220	\$59.62
358-114644		240	\$59.62
358-114645		320	\$59.62
358-114646		400	\$59.62
358-114699		2" x 55 YD	40
358-114700	50		\$96.21
358-114701	60		\$90.43
358-114702	80		\$82.73
358-114703	100		\$78.90
358-114704	120		\$78.90
358-114705	150		\$78.90
358-114706	180		\$78.90
358-114707	220		\$78.90
358-114708	240		\$78.90
358-114710	320	\$78.90	
358-114711	400	\$78.90	



MOUNTED FLAP WHEELS

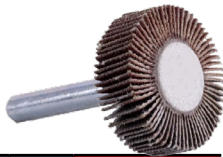

Order #	Size	Grit	Price (ea)
358-129801	3/4" x 3/4" x 1/4"	40	\$1.42
358-129802		60	\$1.42
358-129803		80	\$1.50
358-129804	1" x 5/8" x 1/4"	40	\$1.51
358-129805		60	\$1.57
358-129806		80	\$1.63
358-129807	1" x 1" x 1/4"	40	\$1.86
358-129808		60	\$1.86
358-129809		80	\$2.00
358-129810	1-1/2" x 1/2" x 1/4"	40	\$1.92
358-129811		60	\$2.00
358-129812		80	\$2.07
358-129813	1-1/2" x 1" x 1/4"	40	\$2.58
358-129814		60	\$2.72
358-129815		80	\$2.87
358-129816	2" x 3/4" x 1/4"	40	\$3.16
358-129817		60	\$3.23
358-129818		80	\$3.23
358-129819	2" x 1" x 1/4"	40	\$3.73
358-129820		60	\$3.81
358-129821		80	\$3.95
358-129822	3" x 1" x 1/4"	40	\$6.79
358-129823		60	\$6.94
358-129824		80	\$7.58



FIBRE DISCS



Order #	Size	Grit	Price (ea)
358-113207	4 1/2" x 7/8" (Pkg: 50)	24	\$0.82
358-113215		36	\$0.80
358-113227		50	\$0.74
358-113234		60	\$0.73
358-113242		80	\$0.62
358-113251		100	\$0.62
358-113258		120	\$0.62



Machinist File Sets in Plastic Pouch

Applications:
cutting sheet metal, cutting hollow sections, cutting solid materials



Length [Inches]	Content (each file with appropriate ergonomic handle)	EDP#	Package QTY	Price
10	10" hand bastard, three square bastard, square bastard, tapered half round second cut, round second cut	16080	1	\$55.22
10	10" hand second cut, three square second cut, square second cut, tapered half round second cut, round second cut	16081	1	\$58.74



5 Piece Carbide Bur Sets – OMNI Cut

Contains five carbide burs with 1/4" shank diameter in the shapes and dimensions most commonly used in the workshop.



Set contents shape	Bur dia. d1 [Inches]	Bur length l2 [Inches]	SCTI no.	Cut type and set EDP#		Package QTY	Price
				OMNI	Individual bur EDP's in set		
Cylindrical (plain end)	1/2	1	SA-5	28037	28005	1	\$289.76
Cylindrical (radius end)	1/2	1	SC-5		28001	1	
Oval	1/2	7/8	SE-5		28025	1	
Tree (radius end)	1/2	1	SF-5		28000	1	
14° Taper	1/2	1-1/8	SL-4		28014	1	



SG STEELOX Thin Cut-Off Wheels

Applications:
cutting sheet metal, cutting hollow sections, cutting solid materials

D [Inches]	T/U [Inches]	H [Inches]	EDP#	Max. RPM	Package QTY	Price
Flat (type 1/41) – plain arbor hole						
4-1/2	0.045	7/8	63607	13,300	25	\$3.41
5	0.045	7/8	63608	12,200	25	\$3.80



SG STEEL Grinding Wheels

Applications:
weld dressing, chamfering, deburring, surface grinding, fillet weld edge grinding

D [Inches]	U [Inches]	H [Inches]	EDP#	Max. RPM	Package QTY	Price
Depressed centre (type 27) – plain arbor hole						
4-1/2	1/4	7/8	61026	13,300	10	\$3.56
5	1/4	7/8	61028	12,200	10	\$4.83



POLIFAN Z SG POWER STEELOX Flap Discs

Applications:
chamfering, deburring, and work on weld seams

D [Inches]	H [Inches]	Grit	EDP#	Max. RPM	Package QTY	Price
Conical (type 29, PFC) – plain arbor hole						
4-1/2	7/8	40	62222	13,300	10	\$13.37
4-1/2	7/8	60	62223	12,200	10	\$13.37
5	7/8	40	62225	13,300	10	\$14.75
5	7/8	60	62226	12,200	10	\$14.75

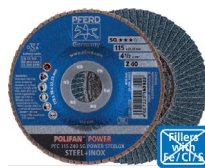

Summer 2024 Promotions

Celebrating 50 Years in Business

----- 1974-2024 -----





classiX - regular duty, GSM series

With even more clamping force, heavy duty pad and classic rail profile, plus a range of clamp openings that will meet most day to day needs.



Simply better.

Order #	Clamping Capacity	Throat Depth	Clamping Force	Approx. Weight	Price
119-GSM20	7 1/2"	4 3/4"	2660 lbs	5.20 lbs	\$87.37
119-GSM25	9"	5 1/2"	2660 lbs	5.75 lbs	\$97.38
119-GSM30	12"	5 1/2"	2660 lbs	6.35 lbs	\$103.53
119-GSM40	16"	5 1/2"	2660 lbs	6.70 lbs	\$116.26
119-GSM50	20"	5 1/2"	2660 lbs	7.40 lbs	\$133.63
119-GSM60	24"	5 1/2"	2660 lbs	8.10 lbs	\$150.85



5555PF Grease Monkey®

- Black heavyweight nitrile
- Powder-free
- 8 mil thickness
- 11" rolled cuff
- CFIA approved
- 50 gloves/dispenser

Order #

295-5555PF-L
295-5555PF-XL
295-5555PF-XXL

Price

\$ 19.95
\$ 19.95
\$ 19.95



Will fully degrade in 10 years in moderate landfill conditions (ASTM D5526) compared to 200 years for regular disposable gloves.



CLOSEOUT PRICE

5556PF Green Monkey™

- Black nitrile
- Powder-free
- 5 mil thickness
- 9.5" rolled cuff
- CFIA approved
- 50 gloves/dispenser

Order #

295-5556PF-L
295-5556PF-XL

Price

\$ 12.95
\$ 12.95

FAST ORANGE® FINE PUMICE LOTION HAND CLEANER, 1 GAL W/PUMP

- ▶ Biodegradable, petroleum solvent free hand cleaner formula
- ▶ Pure, fresh citrus scent
- ▶ Fortified with premium skin conditioners
- ▶ Fine pumice deep cleans the toughest dirt
- ▶ Readily Biodegradable according to OECD Method 301E



Order # 114-25-219 Price: \$21.50

FAST ORANGE® WIPES

- * Textured surface on one side for cleaning heavy duty soils
- * Smooth side for general purpose cleaning
- * Clean grease, grime, oils, soils, and more
- * 72 count container



Order # 114-25051

Price: \$18.95



Combination Square Set

- * Made of cast iron
- * Square head, protractor and center head
- * Stainless steel blade with etched clear graduation
- * Fine milled measuring faces
- * Blade graduation:
 - For metric/inch: top 1/2mm, bottom 1mm,
 - top 1/64" inch, bottom 1/32" inch on rear side
- * Packed in cardboard



EDP #	Blade Size	List Price	SALE Price
370-240-0733	300mm/12"	\$133.47	\$113.45



Dial Test Indicator (INCH)

- * High performance of magnetic proof because of high quality brass main body
- * Jeweled bearing for high sensitivity and long life
- * Carbide contact point ø0.08" for long life
- * 230° big turning range of stylus
- * Total 3 dovetails for fixing attachments
- * Supply with accessories: clamping stems ø1/4" and ø3/8"
- * Packed in cardboard
- * Includes certificate



EDP #	Range	Reading	List Price	SALE Price
370-220-7077	0-0.03" inch	0.001" inch	\$89.78	\$76.31
370-220-7084	0-0.03" inch	0.001" inch	\$94.16	\$80.04
370-220-7091	0-0.03" inch	0.0005" inch	\$95.76	\$81.40
370-220-7107	0-0.008" inch	0.0001" inch	\$163.83	\$139.26



Summer 2024 Promotions

Celebrating 50 Years in Business

----- 1974-2024 -----



CLEARANCE

CALIBER WAREHOUSE
CLEARANCE



SCAN QR Code to visit Our Newly Launched CLEARANCE Center for The Lowest Prices from BIG Brands. We are constantly adding to the range, so come back and make sure you do not miss out on the GREAT Deals!



EUROTECH

Heavy Duty Live Center Made In Europe

Order #	Description	Sale Price
302-LHDR-E3	MT3 Extended 60/40° Center Point	\$178.00
302-LHDR-E4	MT4 Extended 60/40° Center Point	\$191.00
302-LHDR-E5	MT5 Extended 60/40° Center Point	\$355.00

CGW ABRASIVES

VITRIFIED WHEELS

AS3 - Ceramic Aluminum Oxide

- Engineered for fast metal removal with reduced dressing frequency.
- Excels at grinding 50 Rockwell C and harder.
- Submicron crystal structure continually fractures to produce sharp new grinding points.
- Designed for heavier downfeeds and faster traverse rates with excellent form holding capabilities.

ORDER #	DESCRIPTION	PRICE (EA)
359-34209	7 x 1/2 x 1-1/4 T1 AS3-46-J-V CER	\$43.58
359-34212	7 x 1/2 x 1-1/4 T1 AS3-60-J-V CER	\$43.58
359-37771	8 x 1/2 x 1-1/4 T1 AS3-46-J-V CER	\$60.08
359-34215	8 x 1/2 x 1-1/4 T1 AS3-60-J-V CER	\$60.08
359-37773	10 x 1 x 3 T1 AS3-46-J-V CER	\$151.07
359-34223	12 x 1 x 5 T1 AS3-46-J-V CER	\$210.77
359-34239	14 x 1-1/2 x 5 T1 AS3-46-J-V CER	\$398.52

bibielle Abrasive Technologies MADE IN ITALY

BCW-DB DEBURRING CONVOLUTE WHEELS

- Remove medium to heavy burrs
- Remove parting lines from casting and forging
- Deburr Stainless Steel pipe threads and punched holes
- Smooth radius on stamped metal parts
- Polish welds

Dia. x Width x Hole	max	Order #	Sale Price	Order #	Sale Price
6" x 1" x 1"	6,000	220-BCW022	\$74.12	220-BCW026	\$75.67
8" x 1" x 3"	4,500	220-BCW042	\$85.01	220-BCW046	\$93.42

CCMT Non-Coolant Boring Bars

Caliber EDP#	Description	Shank Ø	Length	Kit Price
329-IS05KSCLCR2B	ISO5K-SCLCR-2-B	5/16"	5"	\$82.00
c/w 10pcs 340-705476 CCMT 2(1.5)1-PPM P25C Inserts				
Optional Insert 10pcs 340-705924 CCMT 2(1.5)1-PPM M25C				
329-IS06KSCLCR2B	ISO6K-SCLCR-2-B	3/8"	5"	\$82.00
c/w 10pcs 340-705476 CCMT 2(1.5)1-PPM P25C Inserts				
Optional Insert 10pcs 340-705924 CCMT 2(1.5)1-PPM M25C				
329-IS08MSCLCR2	ISO8M-SCLCR-2	1/2"	6"	\$84.00
c/w 10pcs 340-705476 CCMT 2(1.5)1-PPM P25C Inserts				
Optional Insert 10pcs 340-705924 CCMT 2(1.5)1-PPM M25C				
329-IS08MSCLCR3	ISO8M-SCLCR-3	1/2"	6"	\$92.00
c/w 10pcs 340-705353 CCMT 3(2.5)1-PPM P25C Inserts				
Optional Insert 10pcs 340-705933 CCMT 3(2.5)1-PPM M25C				
329-IS10QSCLCR3B	ISO10Q-SCLCR-3B	5/8"	7"	\$98.00
c/w 10pcs 340-705353 CCMT 3(2.5)1-PPM P25C Inserts				
Optional Insert 10pcs 340-705933 CCMT 3(2.5)1-PPM M25C				
329-IS12RSCLCR3	ISO12R-SCLCR-3	3/4"	8"	\$102.00
c/w 10pcs 340-705353 CCMT 3(2.5)1-PPM P25C Inserts				
Optional Insert 10pcs 340-705933 CCMT 3(2.5)1-PPM M25C				
329-IS16RSCLCR3	ISO16R-SCLCR-3	1"	8"	\$105.00
c/w 10pcs 340-705353 CCMT 3(2.5)1-PPM P25C Inserts				
Optional Insert 10pcs 340-705933 CCMT 3(2.5)1-PPM M25C				

Eco Run Turning Kits

Caliber EDP#	Toolholder	Shank	Kit Price
286-EGML062	MCLNR-164D	1"	\$122.00
c/w 10pcs 340-705457 CNMG432-PM P15C			
Optional Insert 10pcs 340-706867 CNMG432-MM1 M25C			
286-EGML130	MDJNR-164D	1"	\$149.00
c/w 10pcs 340-705570 DNMG432-PM P15C			
Optional Insert 10pcs 340-707521 DNMG432-MM1 M25C			
286-EGML380	MWLN-164D	1"	\$129.00
c/w 10pcs 340-705460 WNMG432-PM P15C			
Optional Insert 10pcs 340-706878 WNMG432-MM1 M25C			
286-EGML318	MTJNR-164D	1"	\$133.00
c/w 10pcs 340-705677 TNMG432-PM P15C			
Optional Insert 10pcs 340-705311 TNMG432-MM M25C			
286-EGML356	MVJNR-163D	1"	\$131.00
c/w 10pcs 340-705711 VNMG332-PM P15C			
Optional Insert 10pcs 340-705328 VNMG332-MM M25C			

WINSTAR CxSN 45° Kits

Caliber EDP#	Cutter Ø	Cutter Length	Bore Ø	# of Teeth	Kit Price
336-IFCXSN505248100	2-1/2"	1.575"	1"	5	\$310.45
C/W 10pcs 336-SNMX1 205-MG CX32HS Inserts					
336-IFCXSN506315100	3"	1.969"	1"	6	\$400.32
C/W 10pcs 336-SNMX1 205-MG CX32HS Inserts					
336-IFCXSN508393120	4"	1.9659"	1.25"	8	\$472.24
C/W 10pcs 336-SNMX1 205-MG CX32HS Inserts					
336-IFCXSN510492150	5"	2.480"	1.50"	10	\$548.23
C/W 10pcs 336-SNMX1 205-MG CX32HS Inserts					

90° INDEXABLE COMBO KIT (STEEL+STAINLESS STEEL)

336-ICAPKE303075404
0.750" X 0.750" X 4.00" OAL, 3-FLUTE, L1=1.00"
c/w 10pcs 336-APKT100308MGXC32HS
APKT-100308PDER-MG-CX32HS MILLING INSERT (Steel)
AND 10pcs 135-11264284
APKT 1003PDSR-29 CTC5235 (Stainless Steel)

SUPER SALE! \$199.00 !!

Value \$380.00

CERATIZIT GROUP

WINSTAR

DORMER PRAMET

50% OFF

Order #	Description	QTY	CLEARANCE Price
102-001436	HYDRA-H 9/16 PSC 140PT HYDRA DRILL HEAD	2	\$69.00
102-001452	HYDRA-H 13/16 PSC 140PT HYDRA DRILL HEAD	1	\$69.00
102-010055	HYDRA-B 14.50 PTD 3XD HYDRA DRILL 35/64	1	\$149.00
102-010155	HYDRA-B 14.50 PTD 5XD HYDRA DRILL 35/64	1	\$149.00
102-010183	HYDRA-B 21.50 PTD 5XD HYDRA DRILL 13/16	1	\$149.00

Order #	Description	QTY	CLEARANCE Price
163-449-553-1	1/2X1-1/4X1/2X3 7FL .030 CORNER RADIUS VARIABLE HELIX ENDMILL, POWER"A"	2	\$56.28
163-449-563-1	1/2X1-5/8X1/2X4 7FL .030 CORNER RADIUS VARIABLE HELIX ENDMILL, POWER"A"	6	\$80.43
163-449-573-1	1/2X2X1/2X4 7FL .030 CORNER RADIUS VARIABLE HELIX ENDMILL, POWER"A"	6	\$87.44

64% OFF

MasterCut Tool Corp.