



# FALL INTO SAVINGS

## Electronic Microscopes



With Stand

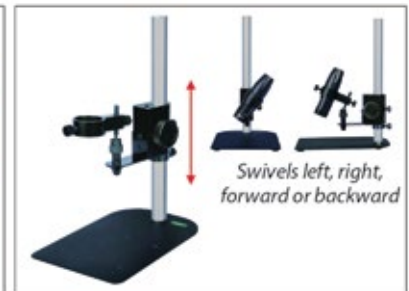

- Records photos and video
- Supplied with measuring software (requires Windows XP SP2, Vista, Windows 7, 8 or 10 operating system)
- Standard or Universal stand
- Magnification: 10x to 200x
- Pixels: 2M (resolution: 1600x1200)
- Built-in adjustable LED
- Power supply: USB 2.0 cable (voltage required: 5±0.1V)

- Includes one of each:**
- Microscope
  - Stand
  - White/Black plate
  - Focus support ring
  - Calibration rule (graduation 0.004"/0.1mm)
  - Calibration rule (graduation 0.039"/1mm)
  - ISM-PRO software CD



Screencapture of ISM-PRO software

Magnification, Focus Distance, View Field and Accuracy			
Magnification (Inch)	Focus Distance (Inch)	View Field (Inch)	Accuracy (mil)
50x	0.83	0.32 x 0.25	1.2
100x	0.51	0.15 x 0.12	0.6
150x	0.63	0.10 x 0.08	0.4
200x	0.75	0.07 x 0.06	0.3

Type	INSIZE No.	Code	Price
Standard	ISM-PM200SA	285000	<b>544<sup>.65</sup></b>
Universal	ISM-PM200SB	285007	<b>598<sup>.40</sup></b>

EXCLUSIVELY AVAILABLE FROM **KAR** IN CANADA

YOUR AUTHORIZED KAR DISTRIBUTOR:



**Caliber Industrial Supply**  
5500 Tomken Rd, Unit #2  
Mississauga, ON L4W 2Z4  
www.caliberindustrial.com

Mississauga: 905.624.5524  
Toronto: 416.626.7151  
Toll Free: 1.800.465.5743  
**sales@caliberindustrial.com**



# FALL INTO SAVINGS

## Pneumatic Tapping Machines

### Universal Tapping Attachments



Code 302803  
**714.40**



Code 302804  
**791.79**

	302803	302804
Range:	90°	90°
Fits Tapping Machine:	302799 302800	302801
Approx. Weight (lbs):	4.41	4.41

AS-12/II | Code 302799

**4259.32**



AT-12/I | Code 302800

**4131.90**



#### TAPPING MACHINES INCLUDE

- Pneumatic tapping spindle
- Stretch arm
- Slanted arm (302799 and 302801 only)
- Table mounting column
- Air unit
- 6 safety clutch tapping adapters

	AS-12/II	AT-12/I	AT-20/II
Tap Capacity (Inch):	0-1/2	0-1/2	0-3/4
Speed (RPM):	400	400	150/400
Work Range (Inch):			
Rmax./Rmin.:	55.12/7.87	62.99/19.69	74.8/7.87
Approx. Weight (lbs):	46.30	44.09	83.78

AT-20/II | Code 302801

**10193.19**



## Cutting Fluids



Description	Size	Price
<b>PROTAP</b> An eco-friendly cutting fluid that is totally biodegradable and can be applied to any and all cutting operations and metals. There is no operation or metal that will stand in your way with Tap Magic ProTap.	 1 gallon	219219 <b>102.18</b>
<b>AQUEOUS</b> Aqueous has a proprietary water base that, unlike most other water-based fluids, is non-corrosive. Highly effective for all cuts on all metals except magnesium.	 1 gallon	219226 <b>102.13</b>

Description	Size	Price
<b>ECO-OIL</b> Eco-Oil has a unique base of natural oil that resists smoking and fuming, even on cuts that produce a lot of heat. Highly effective for all cuts on all metals.	 1 gallon	219233 <b>105.35</b>
<b>XTRA-THICK</b> Ideal for inconel, titanium, stainless and hardened steels. Highly effective on any metal up to 45 RC! Clinging action makes this great for lathes and mill work, since fluid stays on the work piece during high-speed rotation.	 1 gallon	2192239 <b>128.48</b>



## Hand Taps



Metric | Plug & Bottoming Style

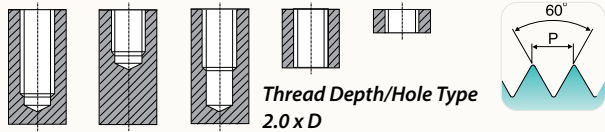

Size & Pitch	Thread Limit	Overall Length (Inch)	Thread Length (Inch)	Plug Style Code	Bottoming Style Code	Price
M1.6 x 0.35	D3	1.63	0.310	915817	-	25.31
M2 x 0.40	D3	1.75	0.440	915818	915847	25.31
M2.5 x 0.45	D3	1.81	0.500	915819	915848	15.35
M3 x 0.50	D3	1.94	0.630	915820	915849	15.49
M3.5 x 0.60	D4	2.00	0.690	915821	915850	12.56
M4 x 0.70	D4	2.13	0.750	915822	915851	12.56
M4.5 x 0.75	D4	2.38	0.880	915823	915852	12.56
M5 x 0.80	D4	2.38	0.880	915824	915853	12.85
M6 x 1.00	D5	2.50	1.000	915825	915854	13.60
M7 x 1.00	D5	2.72	1.130	915826	915855	14.85
M8 x 1.25	D5	2.72	1.130	915827	915856	14.85
M8 x 1.00	D5	2.72	1.130	915828	915857	14.85
M10 x 1.00	D5	2.94	1.250	915829	915858	19.94
M10 x 1.50	D6	2.94	1.250	915830	915859	19.94
M10 x 1.25	D5	2.94	1.250	915831	915860	18.70
M12 x 1.50	D6	3.38	1.660	915832	915861	30.81
M12 x 1.75	D6	3.38	1.660	915833	915862	30.81
M12 x 1.25	D5	3.38	1.660	915834	915863	30.81
M14 x 2.00	D7	3.59	1.660	915835	915864	45.87
M14 x 1.50	D6	3.59	1.660	915836	915865	45.87
M14 x 1.25	D5	3.59	1.660	915837	915866	45.87
M16 x 2.00	D7	3.81	1.810	915838	915867	56.10
M16 x 1.50	D6	3.81	1.810	915839	915868	56.10
M18 x 2.50	D7	4.03	1.810	915840	915869	75.26
M18 x 1.50	D6	4.03	1.810	915841	915870	75.26
M20 x 2.50	D7	4.47	2.000	915842	915871	93.10
M20 x 1.50	D6	4.47	2.000	915843	915872	93.10
M24 x 3.00	D8	4.91	2.220	915844	915873	142.74
M30 x 3.50	D9	5.44	2.560	915845	915874	295.62
M36 x 4.00	D9	6.06	3.000	915846	915875	354.38

## Independent Lathe Chucks

Plain Back – Series 4306

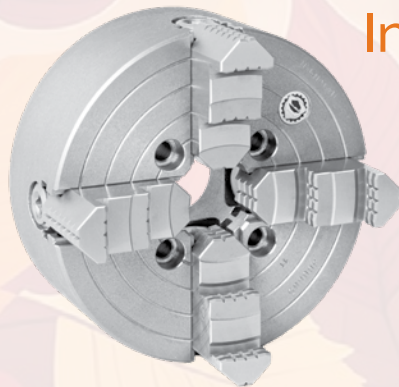

- Steel
- Plain back (Back plates required)
- Chucks 10" diameter and larger have additional T-slots

**Standard Accessories:**

- 1 set of solid reversible jaws
- 1 wrench

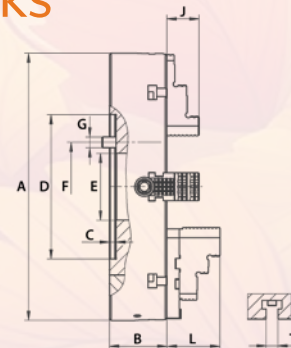

A (Inch)	B (Inch)	C (Inch)	D (Inch)	E (Inch)	F (Inch)	G	J (Inch)	Weight (lbs)	Code	Price
3.39	1.57	0.20	2.44	0.98	2.83	4 x M6	0.67	4.19	355206	1295.15
5.12	1.69	0.10	2.75	1.02	2.13	4 x M8	0.79	10.58	355207	1600.93
6.14	1.69	0.10	3.25	1.65	2.75	4 x M10	0.79	14.55	355208	1314.74



# FALL INTO SAVINGS



## Blue Colour Band Taps

Metric | Spiral Point Plug Style



Size & Pitch	Thread Limit	Overall Length (Inch)	Thread Length (Inch)	No. of Flutes	Code	Price
M2 x 0.4	D3	1-15/16	0.313	2	915463	16.90
M2.5 x 0.45	D3	1-15/16	0.313	2	915465	13.49
M3 x 0.5	D3	1-15/16	0.313	2	915467	11.38
M3.5 x 0.6	D4	2	0.375	2	915469	8.35
M4 x 0.7	D4	2-1/8	0.375	2	915471	8.35
M4.5 x 0.75	D4	2-3/8	0.500	2	915473	8.35
M5 x 0.8	D4	2-3/8	0.500	2	915475	9.59
M6 x 1	D5	2-1/2	0.625	3	915477	9.59
M7 x 1	D5	2-23/32	0.688	3	915479	13.04
M8 x 1	D5	2-23/32	0.688	3	915483	13.04
M8 x 1.25	D5	2-23/32	0.688	3	915481	13.04
M10 x 1.25	D5	2-15/16	0.750	3	915487	20.60
M10 x 1.5	D6	2-15/16	0.750	3	915485	20.60
M12 x 1.25	D5	3-3/8	0.938	3	915491	23.49
M12 x 1.75	D6	3-3/8	0.938	3	915489	23.49
M14 x 1.5	D6	3-19/32	1.000	3	915495	35.19
M14 x 2	D7	3-19/32	1.000	3	915493	35.19
M16 x 1.5	D6	3-13/16	1.094	3	915499	41.50
M16 x 2	D7	3-13/16	1.094	3	915497	41.50
M18 x 1.5	D6	4-1/32	1.094	3	915503	50.84
M18 x 2.5	D7	4-1/32	1.094	3	915501	50.84
M20 x 1.5	D5	4-15/32	1.219	3	915507	66.18
M20 x 2.5	D6	4-15/32	1.219	3	915505	66.18
M22 x 1.5	D6	4-11/16	1.344	3	915511	78.98
M22 x 2.5	D6	4-11/16	1.344	3	915509	78.98
M24 x 1.5	D5	4-29/32	1.344	3	915515	91.68
M24 x 3	D7	4-29/32	1.344	3	915513	91.68

## Straight Edges

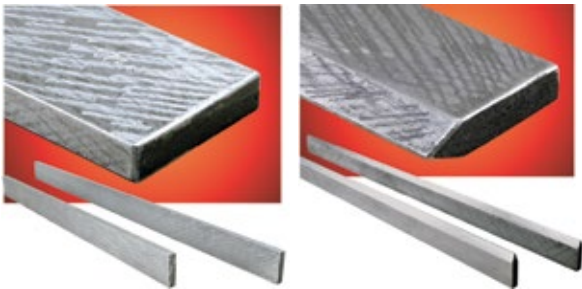

Flat & Bevelled Edges

- Used for drawing and scribing lines, checking various surfaces for straightness, for the set-up of machines such as planers, jointers and machine beds for alignment of tables, work surfaces and other positioning functions
- Two styles available in lengths from 12" (300mm) to 120" (3,000mm): FLAT EDGE: These have flat edges on both sides; BEVELLED EDGE: These are flat on one side and have a bevelled edge on the other side
- Each unit is identified numerically facilitating traceability if calibration is required

Length Inch (mm)	Width Inch	Thickness Inch	Flatness of Edge Inch	Parallelism of Faces Inch	Flat Edge		Bevelled Edge	
					Code	Price	Code	Price
12 (300)	1-13/32	5/16	0.00047	0.00094	840630	84.42	840639	102.04
18 (450)	1-13/32	5/16	0.00047	0.00094	840631	126.76	840640	158.19
24 (600)	1-13/32	5/16	0.00067	0.0013	840632	160.66	840641	209.04
36 (900)	2-13/32	3/8	0.00083	0.0016	840633	316.59	840642	382.45
48 (1200)	2-13/32	3/8	0.0011	0.002	840634	413.03	840643	494.55
60 (1500)	3-5/32	3/8	0.0011	0.002	840635	560.78	840644	647.47
72 (1800)	3-5/32	3/8	0.0015	0.0029	840636	657.79	840645	764.74
96 (2400)	3-5/32	19/32	0.0018	0.0036	840637	1427.51	840646	1733.37
120 (3000)	3-1/4	19/32	0.0021	0.0043	840638	2294.20	840647	2753.08



# SAVE AT KAR



## CNC Spot Drills

Cobalt TiN Coated | Inch & Metric | 90° Angle | Standard Length



Inch

Metric

Body Diameter (Inch)	Decimal Equivalent (Inch)	Flute Length (Inch)	Overall Length (Inch)	Code	Price
1/8	0.125	3/8	2	601032	26.44
3/16	0.188	5/8	2-3/8	601033	31.80
1/4	0.250	7/8	2-5/8	601034	42.47
3/8	0.375	1	3-1/2	601035	54.10
1/2	0.500	1-3/8	4	601036	70.58
5/8	0.625	1-3/8	4-1/2	601037	99.15
3/4	0.750	1-5/8	5-1/8	601038	132.55
1	1.000	1-3/4	5-1/2	601039	236.71

Body Diameter (mm)	Decimal Equivalent (Inch)	Flute Length (Inch)	Overall Length (Inch)	Code	Price
2	0.079	5/16	2	601050	30.38
3	0.118	3/8	2	601051	28.15
4	0.157	1/2	2	601052	31.80
5	0.197	5/8	2-3/8	601053	38.54
6	0.236	3/4	2-5/8	601054	41.75
8	0.315	1	3-1/8	601055	50.14
10	0.394	1	3-1/2	601056	60.98
12	0.472	1-1/4	4	601057	68.90
14	0.551	1-3/8	4-1/2	601058	85.49
16	0.630	1-3/8	4-1/2	601059	106.70
18	0.709	1-5/8	5-1/8	601060	121.87
20	0.787	1-5/8	5-1/8	601061	142.49
25	0.984	1-3/4	5-1/2	601062	228.24

## Chamfering Biconical Cutters

K15 Carbide | Front & Back | Standard 4 Flute Bi-Face 90° Angle



**BI-FACE:** For superior finish operations, Bi-face has a constant relieved profile. Longitudinal or interpolated work for front and back chamfering of edges and holes.

- Special design equals positive cut plus relieving profile
- Unequaled surface finish
- Impressive performance
- Extended tools profile life

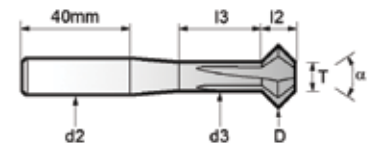

Ø Inch (mm)	d2 (Inch)	d3 Max. (Inch)	T Max. (Inch)	L Min. (Inch)	I2 (Inch)	I3 (Inch)	Code	Price
0.118 (3)	0.236	0.087	0.047	4	0.051	0.394	314198	72.01
0.157 (4)	0.236	0.114	0.063	4	0.069	0.472	314201	74.65
0.197 (5)	0.236	0.134	0.079	4	0.091	0.591	314204	78.69
0.236 (6)	0.236	0.154	0.094	4	0.114	0.709	314207	82.73
0.315 (8)	0.236	0.193	0.193	4	0.118	1.339	314210	107.99
0.394 (10)	0.236	0.232	0.232	4	0.157	1.339	314213	132.06
0.472 (12)	0.236	0.232	0.232	4	0.236	1.339	314216	158.65
0.630 (16)	0.394	0.311	0.311	4	0.315	1.339	314219	212.01

## Tiny Tool Set

Solid Carbide Grade BXC



- For working on small bores
- Bar diameter: 4mm
- PVD TiN coated grade for low cutting speed
- Works well with a wide range of steel and stainless steel

**Complete Set Includes:** Boring bar 570093, profiling bar 570071, threading bar 570078, chamfering bar 570084, grooving bar 570088, face grooving bar 570091, bar holder 570104, and a Torx®15 key

Code 570110

417.60



# FALL INTO SAVINGS

## INSIZE TOOLS THAT MEASURE UP

### Electronic Protractor



Code 877107

**55.87**

- 12 Inch
- 0-360°
- Resolution: 0.1°
- Accuracy: ±0.3°
- Buttons: on/off, zero
- With locking screw
- Graduation of blade: 1/32" and 1mm
- Stainless steel
- Battery CR2032
- Auto power off

### Dial Calipers



- Graduations: 0.001"
- One revolution equals: 0.1"
- Shock proof dial indicator
- Supplied in fitted storage case

0-4 Inch	0-6 Inch	0-8 Inch	0-12 Inch
Accuracy: ±0.0012"	Accuracy: ±0.0015"	Accuracy: ±0.0020"	Accuracy: ±0.0020"
Code 280462	Code 816028	Code 816030	Code 816032

**87.95**

**77.36**

**102.45**

**187.44**

### Fillet Welding Gages



- Measures concave and convex weld sizes
- 7 blades included
- Stainless steel

Size	Accuracy	Code	Price
3mm, 4mm, 5mm, 6mm, 8mm, 9mm, 10mm, 11mm, 12mm, 14mm, 16mm, 19mm, 22mm, 25mm	±0.5mm	877366	<b>48.33</b>
1/8" (3.2mm), 3/16" (4.8mm), 1/4" (6.4mm), 5/16" (7.9mm), 3/8" (9.5mm), 7/16" (11.1mm), 1/2" (12.7mm), 5/8" (15.9mm), 3/4" (19.1mm), 7/8" (22.2mm), 1" (25.4mm)	±0.02" (0.5mm)	877171	<b>52.20</b>

### Electronic Calipers

#### Carbide Tipped Jaws

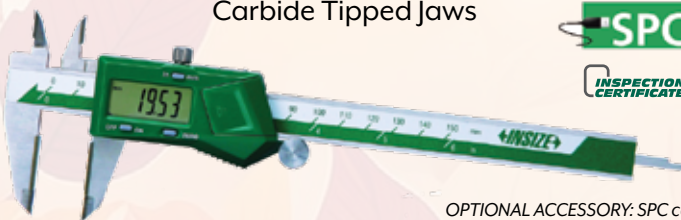

OPTIONAL ACCESSORY: SPC cable

- Resolution: 0.0005"/0.01mm
- Accuracy: ±0.0012"
- Wear resistant carbide tipped jaws for inside and outside measurements
- Buttons: zero, on/off, inch/mm
- Auto power off, move the unit to turn power on
- Battery CR2032
- Stainless steel
- Data output
- Supplied in fitted storage case

Code 280021

**266.29**

Code 280022

**318.52**

Code 280023

**440.65**

#### Absolute

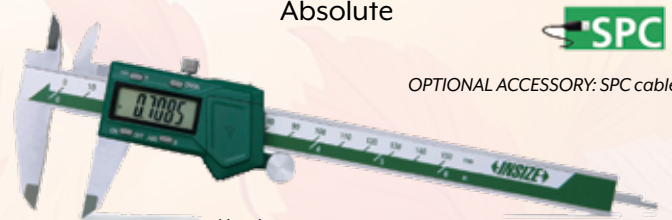

OPTIONAL ACCESSORY: SPC cable

- Absolute system
- Resolution: 0.0005"/0.01mm
- Buttons: Inch/mm, ABS/REL, on/off, origin set
- Battery CR2032
- Auto power off
- Data output
- Stainless steel
- Supplied in fitted storage case

0-6"/0-150mm

Code 285127

**74.47**

0-8"/0-200mm

Code 285128

**104.63**

0-12"/0-300mm

Code 285129

**187.30**

EXCLUSIVELY AVAILABLE FROM **KAR** IN CANADA

# SAVE AT KAR

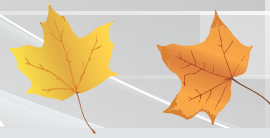

## ←INSIZE→ TOOLS THAT MEASURE UP



### Measuring Tool Set

5 Piece Set  
Code 877372

**244.<sup>68</sup>**

- **Set Includes:**
  - 1) Electronic caliper, range 0-6"/0-150mm, resolution 0.0005"/0.01mm (817000)
  - 2) Outside micrometer, range 0-25mm, graduation 0.01mm (280994)
  - 3) Dial indicator, range 10mm, graduation 0.01mm (282663)
  - 4) Magnetic stand (816252)
  - 5) Micrometer stand (282455)
- Supplied in fitted storage case

EXCLUSIVELY AVAILABLE FROM **KAR** IN CANADA

## SAVE MONEY BY RESHARPENING YOUR DULL DRILLS

### Drill Resharpener Machines

For High Speed Steel, Cobalt and Carbide Straight Shank Drills

Using a patented design, with any standard precision ER collet for clamping and optimum drill alignment, these machines are simple to use with just three easy steps. Just set the drill in the collet, grind the taper relief angle and grind the web thinning angle to reduce the center point width - and DONE! Anyone can use these machines to resharpen dull drills **SAVING YOU MONEY!**

- Grind HSS, cobalt and carbide straight shank drills from 2-26 mm (*Carbide grinding wheel optional*)
- Reduce wear with double-bearing grinding unit
- Precision drill tightening fixture
- Adjustable 85° to 140° point angle



Model DM-213  
Code 620001

2-13 mm **1570.<sup>71</sup>**



12-26 mm Model DM-1226  
Code 620002

**3597.<sup>06</sup>**

*HSS & Carbide  
replacement grinding  
wheels available*

	MODEL DM-213 Code 620001	MODEL DM-1226 Code 620002
DRILL DIAMETER	2 - 13 mm	12 - 26 mm
POINT ANGLE	85°-140°	
POWER SUPPLY	110V	
MOTOR	150 W	373 W
RPM	6000	4000
WEIGHT	10 kg	29 kg
DIMENSIONS   L X W X H	305 x 172 x 180 mm	470 x 260 x 235 mm
ER COLLETS INCLUDED	12 pcs. ER20 2.5 mm - 13 mm	15 pcs. ER40 12 mm - 26 mm
CBN DIAMOND WHEEL	1 pc. #200 (HSS drill)	1 pc. #150 (HSS drill)
HEXAGON WRENCH	4 mm and 5 mm	4 mm and 6 mm



These products evaluated to the model code SPE-1000 by the Electrical Safety Authority



# FALL INTO SAVINGS



## Deburring

**SHAVIV**  
Leading Deburring Solutions

Exclusively Available at **KAR** in Canada

### Set HC5 Handy Chuck

- Delivers pin vise versatility for finishing & scraping applications
- Also used for gripping miniature files, drills, reamers, taps, wires, countersinks and other small objects - 0.04" to 0.32" (1 to 8mm) in diameter
- Handy for assembling electronic components and watch repair
- Deburrs steel, aluminum, copper, brass, cast iron, stainless steel and plastics



Blade C50  
Code 550937

**81.21**

- Straight Edge
- Hole Edge
- Hole Back-Edge
- Flat Surface
- Hole Inner Surface

### Mango II Set C The Scraper



- Features triangular blades with 3 cutting edges (C42) for high quality finishing and scraping
- Telescopic blade holder enables getting in to difficult-to-reach areas
- Includes key for safely removing blades
- Mango II handle provides maximum comfort
- Deburrs steel, aluminum, copper, brass, cast iron, stainless steel and plastics

- Straight Edge
- Hole Edge
- Hole Back-Edge
- Flat Surface
- Hole Inner Surface

Mango II Set C  
C42 Blades  
Code 550609

**31.40**

Mango II Set C40  
C40 Blades  
Code 550610

**25.81**

## Grooving Inserts

Carbide – Internal & External



CARBIDE GRADE BXC: P30-P50  
K25-K40

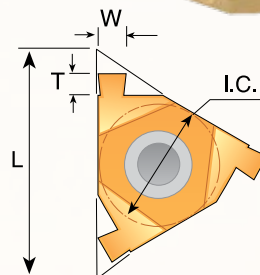

External Right Hand  
or Internal Left Hand

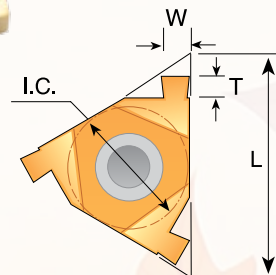

Internal Right Hand  
or External Left Hand

- PVD TiN coated grade for low cutting speed
- Works well with a wide range of steel and stainless steel

NOTE: Shim must be changed to AE 16-0 or AI 16-0

Change shim from threading to grooving and use the same threading toolholder

### Internal IR/EL

Description	I.C. (Inch)	W ±0.001" (Inch)	T (Inch)	L (mm)	Code	Price
16 IR/EL 0.039	3/8	0.039	0.055	16	570685	<b>24.46</b> /ea.
16 IR/EL 0.047	3/8	0.047	0.063	16	570686	
16 IR/EL 0.055	3/8	0.055	0.071	16	570687	
16 IR/EL 0.067	3/8	0.067	0.079	16	570688	
16 IR/EL 0.077	3/8	0.077	0.079	16	570689	
16 IR/EL 0.089	3/8	0.089	0.089	16	570690	

### External ER/IL

Description	I.C. (Inch)	W ±0.001" (Inch)	T (Inch)	L (mm)	Code	Price
16 ER/IL 0.039	3/8	0.039	0.055	16	570675	<b>24.46</b> /ea.
16 ER/IL 0.047	3/8	0.047	0.063	16	570676	
16 ER/IL 0.055	3/8	0.055	0.071	16	570677	
16 ER/IL 0.067	3/8	0.067	0.079	16	570678	
16 ER/IL 0.077	3/8	0.077	0.079	16	570679	
16 ER/IL 0.089	3/8	0.089	0.089	16	570680	



**KAR Industrial Inc.**  
[www.kar.ca](http://www.kar.ca)

Toronto.....1-800-387-3127  
Montréal.....1-800-363-7862  
Edmonton.....1-866-440-4326

Offer valid until December 31, 2024

\*Products shown may not be exactly as illustrated Code 000338

MAKING IT EASY TO DO BUSINESS WITH SINCE 1954... CONTACT YOUR LOCAL KAR DISTRIBUTOR TODAY!