

WAREHOUSE CLEAROUT



Call: 905.624.5524



Email: sales@caliberindustrial.com

CONTENTS

HSS + COBALT DRILLS	PAGE 2
CARBIDE DRILLS	PAGE 3
TAPPING & THREADING - H.S.S	PAGE 4
THREADMILLING	PAGE 5
END MILLS H.S.S	PAGE 6
END MILLS CARBIDE	PAGES 7 - 8
INDEXABLE TURNING	PAGES 9 - 11
INDEXABLE GROOVING/PARTOFF	PAGES 12 - 13
INDEXABLE MILLING	PAGES 14 - 19
SPINDLE TOOLING	PAGE 20
WORKHOLDING	PAGES 21 - 24
ABRASIVES	PAGE 25
PRECISION TOOLS	PAGE 26

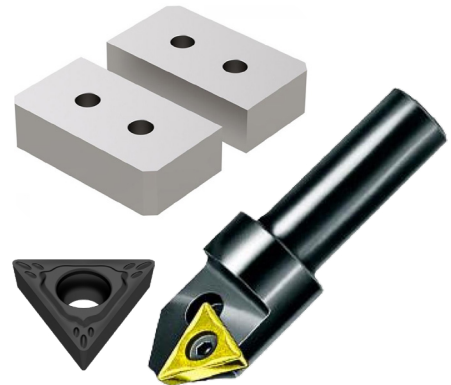



COUNTERSINKS

CLEAROUT



Ordering Code	Size	Flute #	Degree	QTY	PRICE
149-120-733	7/8"	6	90	1	\$19.99

DORMER PRAMET

Save 70% NOW!!

SUPER SALE!



Order#	Description	Type	List Price	CLEARANCE
102-020136	1-9/16 List 209 MTS 118 Degree	Taper Shank Drill	\$719.00	\$215.70 ONLY 3 Left!
102-020160	1-15/16 List 209 MTS 118 Degree	Taper Shank Drill	\$1,096.00	\$328.80 ONLY 1 Left!
102-5999962	HSS - Black 1/2" Shank - 23/32 List R56	Prentice Drill	\$104.00	\$31.12 ONLY 3 Left!
102-5999973	HSS - Black 1/2" Shank - 29/32 List R56	Prentice Drill	\$142.00	\$42.60 ONLY 2 Left!
102-5999980	HSS - Black 1/2" Shank - 31/32 List R56	Prentice Drill	\$161.00	\$48.30 ONLY 8 Left!



Jobber Length Drill Bits Full TiN Coating

Order Number	Description	QTY	CLEARANCE PRICE
112-5103-1009	9/64" KOMBAT JBR DRILL	12	\$0.78
112-5103-1017	17/64" KOMBAT JBR DRILL	18	\$1.76
112-5103-1026	13/32" KOMBAT JBR DRILL	2	\$4.63



Warehouse CLEARANCE







Warehouse CLEARANCE 



SOWA
TOOLING YOUR WORLD

Spiral Point 

Order Number	Description	QTY	CLEARANCE PRICE
149-119-717	1 -8 3FL SP/PT - UNC	1	\$92.17
149-119-727	5/16-24 2FL SP/PT - UNF	1	\$7.56
149-119-755	M4.5X.75 3FL SP/PT - METRIC	1	\$8.42
149-119-761	M10X1.25 3FL SP/PT - METRIC	1	\$9.72
149-119-763	M12X1.25 3FL SP/PT - METRIC	1	\$14.58

Spiral Flute 

149-119-819	5/16-24 3FL SP/FLUTE - UNF	2	\$9.79
149-119-820	3/8-24 3FL SP/FLUTE - UNF	1	\$11.34

GREENFIELD INDUSTRIES 

REDUCED NECK
MODIFIED STANDARD 

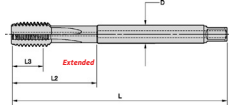



Order Number	Description	QTY	CLEARANCE PRICE
122-25836RED	6-32 H3 2FL GP/DIN LENGTH TAP	1	\$6.23
122-25842RED	10-24 H3 3FL GP/DIN LENGTH TAP	1	\$6.23
122-25872RED	M10X1.5 D6 3FL GP/DIN LENGTH TAP	2	\$15.29

CLEVELAND 

122-C97085	NO.8-32 HS G H3 2F PL SPPT BLUE DIA TAP	2	\$9.44
122-C97139	1/4-28 HS G H3 2F PL SPPT BLUE DIA TAP	2	\$11.66

FEQ 

MADE IN USA 

SPIRAL FLUTE - BLIND HOLE
** PREMIUM HSS ** 

Order#	Description	QTY	CLEARANCE
139-14618	3/8-24 H3 SP/FL BOT TAP FEQ - Black Oxide	9	\$6.99
139-14637	8-32 H5 SP/FL BOT TAP FEQ - Black Oxide	7	\$3.99
139-14639	10-24 H5 SP/FL BOT TAP FEQ - Black Oxide	5	\$5.99
139-14644	1/4-28 H5 SP/FL BOT TAP FEQ - Black Oxide	2	\$5.99
139-14647	3/8-16 H5 SP/FL BOT TAP FEQ - Black Oxide	6	\$6.99
139-14658	3/4-16 H5 SP/FL BOT TAP FEQ - Black Oxide	1	\$39.99

BROOKE 

MADE IN THE UK **RED RING FOR HARD MATERIALS** 

>> SPIRAL FLUTE <<

Order Number	Description	QTY	CLEARANCE PRICE
112-5BA1110	7/16X14 UNC RED BND - SPIRAL FLUTE	1	\$16.33
112-5BL0480	NO10X32 UNF RED BND - SPIRAL FLUTE	4	\$8.91
112-5EA2200	M22 X 2.5 RED BAND - SPIRAL FLUTE	1	\$65.93

>> SPIRAL POINT << **RED RING FOR HARD MATERIALS** 

112-5BF1110	7/16X14 UNC RED BND - SPIRAL POINT	1	\$13.97
112-5BF1430	9/16X12 UNC RED BND - SPIRAL POINT	1	\$24.81
112-5BS0480	NO10X32 UNF RED BND - SPIRAL POINT	3	\$8.27
112-5BS0790	5/16X24 UNF RED BND - SPIRAL POINT	1	\$10.28

>> SPIRAL FLUTE << **YELLOW RING FOR SOFT MATERIALS** 

112-5BC0420	8 X32 UNC YELLOW BAND - SPIRAL FLUTE	7	\$6.93
-------------	--------------------------------------	---	---------------

>> SPIRAL POINT << **BLUE RING FOR TOUGH MATERIALS** 

112-5BG1594	5/8X11 UNC BLUE BAND - SPIRAL POINT	9	\$19.04
112-5BT0484	NO10X32 UNF BLUE BND - SPIRAL POINT	10	\$6.34
112-5BT2544	1 X 12 UNF BLUE BAND - SPIRAL POINT	2	\$52.90

>> SPIRAL FLUTE << **BLUE RING FOR TOUGH MATERIALS** 

112-5BB0354	NO6X32 UNC BLUE BAND - SPIRAL FLUTE	21	\$6.77
112-5BB0424	NO8X32 UNC BLUE BAND - SPIRAL FLUTE	6	\$6.93
112-5BB0484	NO10X24 UNC BLUE BND - SPIRAL FLUTE	13	\$7.30
112-5BB1114	7/16X14 UNC BLUE BND - SPIRAL FLUTE	10	\$13.78
112-5BM0354	NO6X40 UNF BLUE BAND - SPIRAL FLUTE	10	\$7.34
112-5BM0424	NO8X36 UNF BLUE BAND - SPIRAL FLUTE	4	\$7.34
112-5BM0644	1/4X28 UNF BLUE BAND - SPIRAL FLUTE	11	\$7.99
112-5BM0794	5/16X24 UNF BLUE BND - SPIRAL FLUTE	3	\$9.37
112-5BM0954	3/8X24 UNF BLUE BAND - SPIRAL FLUTE	1	\$9.92



UN THREAD MILLS

15° HELICAL FLUTE SOLID CARBIDE



SAVE 30%

- ▶ Cuts UNC, UNF, UNEF, UNS and UNJ (internal only)
- ▶ Non-crest cutting allows maximum flexibility for plated and non-standard threads
- ▶ Long length-of-cut

Order #	Description	QTY	List Price (USD)	CLEAROUT (CAD)
132-100191	TIALN (4.5-.75MM PITCH) INTERNAL .125 DIA X 5/16 LOC (3 FLUTE) (1/4 SHANK) 2-3/8 OAL	1	\$139.98	\$139.98
132-100719	TIALN (M4.5-0.75 PITCH) INT 3.00 DIA X 6-LOC (3 FL) 6MM SHANK 58MM OAL	1	\$119.48	\$119.48
132-100722	TIALN (M5.0-0.80 PITCH) INT 3.00 DIA X 8-LOC (3 FL) 6MM SHANK 58MM OAL	1	\$119.48	\$119.48
132-100725	TIALN (M6.0-1.00 PITCH) INT 4.30 DIA X 12-LOC (3 FL) 6MM SHANK 58MM OAL	1	\$132.87	\$132.87
132-100728	TIALN (M8.0-0.75 PITCH) INT 6.00 DIA X 16-LOC (3 FL) 6MM SHANK 58MM OAL	1	\$153.47	\$153.47
132-100734	TIALN (M8.0-1.25 PITCH) INT 6.00 DIA X 16-LOC (3 FL) 6MM SHANK 58MM OAL	1	\$153.47	\$153.47
132-100931	TIALN 12-1MM PITCH .400 DIA X 1LOC (4 FLUTE) (1/2 SHANK) 3-1/2 OAL	1	\$225.75	\$225.75
132-101070	TIALN (1/4 3/8-18 PITCH) .382 DIA X 3/4 LOC (4 FLUTE) (7/16 SHANK) 3-1/2 OAL	1	\$184.47	\$184.47
132-101079	TIN (1/2 3/4-14 PITCH) .430 DIA X 1 LOC (4 FLUTE) (1/2 SHANK) 3-1/2 OAL	3	\$221.55	\$221.55
132-101360	TIALN 1/4 3/8-18 PITCH .270 DIA X 5/8 LOC (4 FLUTE) 5/16 SHANK 3 OAL	1	\$169.95	\$169.95
132-101366	TIALN 1/2 3/4-14 PITCH .440 DIA X 7/8 LOC (4 FLUTE) 1/2 SHANK 4 OAL	1	\$183.75	\$183.75
132-102943	TIALN (8-32 PITCH) INT .115 DIA X 1/4-LOC (3 FL) 1/4 SHANK 2-1/2 OAL	1	\$122.57	\$122.57
132-102946	TIALN (10-24 PITCH) INT .120 DIA X 5/16-LOC (3 FL) 1/4 SHANK 2-1/2 OAL	1	\$122.57	\$122.57
132-102949	TIALN (10-28 PITCH) INT .120 DIA X 5/16-LOC (3 FL) 1/4 SHANK 2-1/2 OAL	1	\$122.57	\$122.57
132-102955	TIALN (1/4-20 PITCH) INT .180 DIA X 1/2-LOC (3 FL) 1/4 SHANK 2-1/2 OAL	1	\$132.87	\$132.87
132-102958	TIALN (1/4-28 PITCH) INT .180 DIA X 1/2-LOC (3 FL) 1/4 SHANK 2-1/2 OAL	1	\$132.87	\$132.87
132-102961	TIALN (5/16-18 PITCH) INT .234 DIA X 5/8-LOC (3 FL) 1/4 SHANK 2-1/2 OAL	1	\$143.17	\$143.17
132-102964	TIALN (5/16-24 PITCH) INT .234 DIA X 5/8-LOC (3 FL) 1/4 SHANK 2-1/2 OAL	1	\$143.17	\$143.17
132-102994	TIALN (3/8-24 PITCH) INT .285 DIA X 3/4-LOC (4 FL) 5/16 SHANK 3 OAL	1	\$168.92	\$168.92
132-103000	TIALN (7/16-14 PITCH) INT .305 DIA X 7/8-LOC (4 FL) 5/16 SHANK 3 OAL	1	\$168.92	\$168.92
132-103027	TIALN (1/2-13 PITCH) INT .350 DIA X 7/8-LOC (4 FL) 3/8 SHANK 3 OAL	1	\$174.07	\$174.07
132-103030	TIALN (9/16-12 PITCH) INT .370 DIA X 7/8-LOC (4 FL) 3/8 SHANK 3 OAL	1	\$174.07	\$174.07
132-103033	TIALN (9/16-18 PITCH) INT .370 DIA X 7/8-LOC (4 FL) 3/8 SHANK 3 OAL	1	\$174.07	\$174.07
132-103063	TIALN (5/8-11 PITCH) INT .470 DIA X 1-1/4-LOC (4 FL) 1/2 SHANK 4 OAL	1	\$204.75	\$204.75
132-103066	TIALN (3/4-10 PITCH) INT .495 DIA X 1-1/4-LOC (4 FL) 1/2 SHANK 4 OAL	1	\$204.75	\$204.75
132-103072	TIALN (3/4-14 PITCH) INT .495 DIA X 1-1/4-LOC (4 FL) 1/2 SHANK 4 OAL	1	\$204.75	\$204.75
132-103075	TIALN (3/4-16 PITCH) INT .495 DIA X 1-1/4-LOC (4 FL) 1/2 SHANK 4 OAL	2	\$204.75	\$204.75
132-103111	TIALN (1-8 PITCH) INT .620 DIA X 1-3/8-LOC (4 FL) 5/8 SHANK 4 OAL	1	\$248.60	\$248.60
132-103126	TIALN (M12-1.00 PITCH) INT 9.15 DIA X 22-LOC (4 FL) 10MM SHANK 100MM OAL	3	\$190.55	\$190.55
132-103129	TIALN (M12-1.75 PITCH) INT 9.15 DIA X 22-LOC (4 FL) 10MM SHANK 100MM OAL	1	\$190.55	\$190.55
132-103132	TIALN (M14-1.50 PITCH) INT 9.40 DIA X 22-LOC (4 FL) 10MM SHANK 100MM OAL	1	\$190.55	\$190.55
132-103144	TIALN (M16-2.00 PITCH) INT 11.94 DIA X 32-LOC (4 FL) 12MM SHANK 100MM OAL	1	\$200.85	\$200.85
132-103147	TIALN (M18-1.50 PITCH) INT 11.94 DIA X 32-LOC (4 FL) 12MM SHANK 100MM OAL	1	\$200.85	\$200.85
132-103156	TIALN (M10-1.50 PITCH) INT 7.62 DIA X 20-LOC (4 FL) 8MM SHANK 75MM OAL	1	\$168.92	\$168.92
132-103501	TIALN (7/16-24 PITCH) .345 DIA X 3/4 LOC (4 FLUTE)(3/8 SHANK) 3-1/2 OAL	1	\$210.12	\$210.12



HSS THROWAWAY END MILLS



Order Number	Description	QTY	CLEARANCE
112-5380-1014	7/32 STD THROWAWAY ENDMILL	5	\$3.50
112-5380-3014	7/32 STD THROWAWAY TIN ENDMILL	10	\$4.50
112-5381-1014	7/32" THROWAWAY CUTTER-LONG	1	\$3.00



Minicut

General Purpose Steel Application

CLEARANCE H.S.S. & COBALT ENDMILLS

Order #	Description/Size	QTY	PRICE	
	133-0205-0007	7/32 3/8 1/2 2-5/16 2FL-Regular Length	4 \$5.99	
	133-0205-0012	3/8 3/8 9/16 2-5/16 2FL-Regular Length	3 \$5.99	
	133-0205-0016-12	1/2 3/8 13/16 2-1/2 2FL-Regular Length	1 \$8.99	
	133-0205-0020	5/8 5/8 1-5/16 3-7/16 2FL-Regular Length	1 \$11.99	
	133-0215-0040	1-1/4 1-1/4 3 5-1/2 2FL-Long Length	1 \$40.99	
	133-0215-0044	1-3/8 1 3 5-1/2 2FL-Long Length	1 \$44.99	
	133-0215-0048	1-1/2 1-1/4 3 5-1/2 2FL-Long Length	3 \$48.99	
	133-0215-0060	1-7/8 1-1/4 3 5-1/2 2FL-Long Length	2 \$59.99	
	133-0275-0010	5/16 3/8 3/4 2-1/2 2FL-For Aluminum	1 \$7.99	
	133-0225-0004	1/8 3/8 3/16 2-1/16 2FL	1 \$5.99	
	133-0225-0006	3/16 3/8 3/16 2-1/16 2FL	2 \$5.99	
	133-0225-0008	1/4 3/8 1/4 2-1/16 2FL	24 \$5.99	
	133-0225-0010	5/16 3/8 5/16 2-1/16 2FL	2 \$5.99	
	133-0230-0010	5/16 3/8 9/16 3-1/8 2FL-Regular Length	1 \$8.99	
	133-0230-0018	9/16 5/8 1-1/8 4-1/2 2FL-Regular Length	1 \$17.99	
	133-0230-0032	1 1 1-5/8 5-7/8 2FL-Regular Length	1 \$32.99	
	133-0255-0004	1/8 3/8 3/8 3-1/16 2FL	7 \$5.99	
	133-0405-0004	1/8 3/8 3/8 2-5/16 4FL-Regular Length	2 \$5.99	
	133-0405-0006	3/16 3/8 1/2 2-3/8 4FL-Regular Length	2 \$5.99	
	133-0405-0032	1 1 2 4-1/2 4FL-Regular Length	1 \$20.99	
	133-0405-0032-A	1 1 2 4-1/2 6FL-Regular Length	2 \$20.99	
	133-0460-0013	13/32 1/2 1 4-1/8 4FL-Regular Length	1 \$11.99	
	133-0460-0015	15/32 1/2 1 4-1/8 4FL-Regular Length	5 \$12.99	
	133-0860-0004	1/8 3/8 3/8 2-5/16 4FL-Cobalt	1 \$7.99	
	133-0875-0048-8	1-1/2 1-1/4 8 10-1/2 6FL-Cobalt	3 \$163.99	
	133-0880-0012	3/8 3/8 3/4 2-1/2 4FL-Cobalt	2 \$17.99	
		133-0810-2030	5/8 5/8 3 5-1/8 4FL-Coarse Pitch	1 \$30.99
		133-0815-1008	5/16 3/8 3/4 2-1/2 4FL-Fine Pitch	3 \$12.99
	133-1205-0010	5/16 3/8 1/2 2-11/32 2FL-Threaded Shank	4 \$4.99	
	133-1205-0012	3/8 3/8 9/16 2-3/8 2FL-Threaded Shank	1 \$4.99	
	133-1215-0022	11/16 5/8 1-3/8 4-1/2 2FL-Threaded Shank	3 \$14.99	
	133-1215-0032	1 1 1-3/4 6-1/4 2FL-Threaded Shank	4 \$24.99	
	133-1405-0011	11/32 3/8 27/32 2-5/8 4FL-Threaded Shank	1 \$4.99	
	133-1405-0014	7/16 1/2 3/4 2-5/8 4FL-Threaded Shank	2 \$6.99	
	133-1415-0028	7/8 1 3-3/8 5-5/8 6FL-Threaded Shank	8 \$14.99	
133-1860-0018	9/16 1/2 1-1/8 2-7/8 4FL-Threaded Shank	1 \$19.99		



STM ROUGHERS

Not for hard materials

Special HSS/ALU Alloy mix for increased heat dissipation



MILD STEEL APPLICATIONS

Order #	Size	MATERIAL	COATING	QTY	CLEAROUT
149-102-502S	5/16"X3/8X3/4X2-1/2	HSS-ALU	BRIGHT	38	\$8.99
149-102-508S	5/8"X5/8X1-5/8X3-3/4	HSS-ALU	BRIGHT	20	\$19.99
149-102-522S	1-1/2"X1-1/4X2X4-1/2	HSS-ALU	BRIGHT	4	\$49.99



Warehouse CLEARANCE



Call: 905.624.5524

Email: sales@caliberindustrial.com



LAST ONE



5944T 5/16 X 5/16
2FL SE SC ALTN
Order#: 182-90092

CLEARANCE: \$12.00



2 Flute for Aluminum - 250 Series



Order Number	Description	QTY	CLEARANCE PRICE
172-250-31220-C5	5/16 X 5/16 X 1-1/4 X 3-1/2 2FL SEEM AL	1	\$43.42
172-250-31232-C5	5/16 X 5/16 X 2-1/8 X 4 2FL SEEM ALUM Z	3	\$45.37
172-250-37508BN	3/8 X 3/8 X 1/2 X 2-1/2 2FL SEEM ALUM B-UNCOATED	2	\$35.55
172-250-37508BN-C5	3/8 X 3/8 X 1/2 X 2-1/2 2FL SEEM ALUM BALLNOSE-ZRN	2	\$40.55

2 Flute Variable Helix for Aluminum - 251 Series



172-251S2500-C5	1/4 X 1/4 X 3/8 X 2-1/2 2FLV-SERIES STU	1	\$19.93
172-251S4375-C5	7/16 X 7/16 X 9/16 X 2-3/4 2 FLT STUB SE	1	\$47.08
172-251S7500-C5	3/4 X 3/4 X 1 X 4 2 FLT STUB SE V-SERIES	1	\$125.58

3 Flute for Aluminum - 350 Series



172-350-75016NS40	3/4 X 3/4 X 1 X 5 3FL SEEM ALUM NECKED	1	\$71.97
172-350-75024-C5	3/4 X 3/4 X 1-1/2 X 4 3FL SE ALUM ZRN	4	\$133.99
172-350-75032	3/4 X 3/4 X 2 X 5 3FL SEEM ALUM	1	\$149.00

4 Flute Variable Helix with Corner Radius for Steel - 436 Series



172-436S2500-C10	1/4X3/8 VH 4FL S/C COATED E/M	1	\$16.89
172-436S3125-C10	5/16X7/16 VH 4FL S/C COATED E/M	1	\$20.67
172-436-3125-C10	5/16X13/16 VH 4FL S/C COATED E/M	1	\$25.71
172-436-3750-C10	3/8X1 VH 4FL S/C COATED E/M	1	\$31.79
172-436-7500-C10	3/4X1-5/8 VH 4FL S/C COATED E/M	2	\$145.79
172-436S4375-C11	7/16 X 7/16 X 9/16 X 2-1/2 4FL SE V-SER	3	\$32.14
172-436S5000-C11	1/2 X 1/2 X 5/8 X 2-1/2 4FL SEEM V-SERI	2	\$43.19
172-436-2500BN-C10	1/4X3/4 B/N H.V. 3FL CARB E/MILL	1	\$19.50
172-436-5000BN-C11	1/2 X 1/2 X 1-1/4 X 3 4FL SEEM V-SERIES	2	\$65.73

4 Flute Variable Helix with Corner Chamfer for Steel - 446 Series



172-446S2500-C10	1/4X3/8X.010 VHC 4FL S/C COATED E/M	1	\$16.89
172-446S3125-C10	5/16X7/16X.010 VHC 4FL S/C COATED E/M	1	\$20.57
172-446-3125-C10	5/16X13/16X.010 VHC 4FL S/C COATED E/M	1	\$25.71
172-446S3750-C10	3/8X1/2X.015 VHC 4FL S/C COATED E/M	1	\$26.49
172-446-5000-C10	1/2X1-1/4X.015 VHC 4FL S/C COATED E/M	2	\$52.72
172-446S7500-C10	3/4X1X.020 VHC 4FL S/C COATED E/M	1	\$119.32
172-446-7500-C10	3/4X1-5/8X.020 VHC 4FL S/C COATED E/M	1	\$145.79
172-446S2500-C11	1/4 X 1/4 X 3/8 X 2 4FL SEEM V-SERIES S	1	\$16.89
172-446S3125-C11	5/16 X 5/16 X 7/16 X 2 4FL SEEM V-SERIE	1	\$20.67
172-446-3125-C11	5/16 X 5/16 X 13/16 X 2-1/2 4FL SEEM V	1	\$25.71
172-446S3750-C11	3/8 X 3/8 X 1/2 X 2 4FL SEEM V-SERIES S	1	\$26.49
172-446S4375-C11	7/16 X 7/16 X 9/16 X 2-1/2 4FL SE V-SER	2	\$32.14
172-446-4375-C11	7/16 X 7/16 X 1 X 2-3/4 4FL SE V-SERIES	1	\$39.94
172-446S5000-C11	1/2 X 1/2 X 5/8 X 2-1/2 4FL SEEM V-SERI	1	\$43.19
172-446-5000-C11	1/2 X 1/2 X 1-1/4 X 3 4FL SEEM V-SERIES	1	\$52.72
172-446S7500-C11	3/4 X 3/4 X 1 X 3 4FL V-SERIES STUB SEE	2	\$119.32



**XX-STAR
INCH - MILLING**

Order#	Description	QTY	CLEAROUT
300-XXR404A012	3/16'X3/8'X2'X3/16' (.015") CORNER RADIUS TIALN-SH	1	\$8.64
300-XXR404A048	3/4'X1'X3'X3/4' (.030") CORNER RADIUS TIALN-SH	2	\$85.03



Order Number	Description	QTY	CLEARANCE PRICE
133-2000-22340	3/8 3/8 1-1/8 3 2FL UNCOATED	118	\$22.71
133-2000-22380	1/2 1/2 2 4 2FL UNCOATED	10	\$36.46
133-2000-22395	5/8 5/8 1-1/4 3-1/2 2FL UNCOATED	2	\$51.50
133-2000-22415	3/4 3/4 1-1/2 4 2FL UNCOATED	30	\$75.23
133-2000-22660	1/32 1/8 3/32 1-1/2 TICN	1	\$10.17
133-2000-22955	1/4 1/4 1-1/8 3 2FL TIALN SUPREME	83	\$20.59
133-2000-22960	5/16 5/16 1/2 2 2FL TIALN SUPREME	188	\$16.54
133-2000-22965	5/16 5/16 13/16 2-1/2 2FL TIALN SUPREME	154	\$18.75
133-2000-22985	3/8 3/8 1-1/8 3 2FL TIALN SUPREME	179	\$29.14
133-2000-23025	1/2 1/2 2 4 2FL TIALN SUPREME	43	\$46.67



133-2050-23215	5/8 5/8 2-1/4 5 2FL BN UNCOATED	2	\$91.36
133-2050-23720	5/8 5/8 1-1/4 3-1/2 2FL BN TIALN SUPREME	1	\$68.22



133-3000-23875	5/16 5/16 1-5/8 4 3FL UNCOATED	11	\$21.90
----------------	--------------------------------	----	----------------



133-4035-21385	7/16 7/16 5/8 2-1/2 4FL TIALN SUPREME	1	\$49.91
133-4035-21415	3/4 3/4 1 3 4FL TIALN SUPREME	2	\$107.45



133-4050-26350	1 1 3 6 4FL BN UNCOATED	2	\$237.05
----------------	-------------------------	---	-----------------



133-5045-22140	1/2X1/2X5/8X2-1/2 5FL TIALN SUPREME ENDMILL	1	\$39.00
----------------	---	---	----------------



3 FLUTE ALU-ROUGHER W/ CHIPBREAKERS



Order Number	Description	QTY	CLEARANCE PRICE
210-CID-AL3-CB4375	ENDMILL-ALU-3FL-7/16"	4	\$40.00
210-CID-AL3-CB6250	ENDMILL-ALU-3FL-5/8"	1	\$84.00
210-CID-AL3-CB1000-E	1" CID 3FL UNCOATED W/ CHIPBREAKER ECC REL	4	\$125.00

3 FLUTES SQUARE ALTN COATED



210-CID-SS1000	ENDMILL-SQ-3FL-TIALN-1"	1	\$111.50
----------------	-------------------------	---	-----------------

3 FLUTE BALL NOSE TICN COATED



210-CID-TC-BSS1250	ENDMILL-BALL-3FL-TICN COATED-1/8"	1	\$7.38
210-CID-TC-BSS4375	ENDMILL-BALL-3FL-TICN COATED-7/16"	10	\$30.72
210-CID-TC-BSS6250	ENDMILL-BALL-3FL-TICN COATED-5/8"	7	\$66.77
210-CID-TC-BSS1000	ENDMILL-BALL-3FL-TICN COATED-1"	6	\$134.20

4 FLUTE BALL NOSE-UNCOATED



210-CID-B2500	ENDMILL-BALL-4FL-1/4 (4050-26230)"	2	\$10.95
---------------	------------------------------------	---	----------------

4 FLUTE ROUGHER, FINE PITCH, ALTN COATED



210-CID-RO-STD1000	ROUGHER-4FL-TIALN-1 (4035-21425)"	1	\$179.98
--------------------	-----------------------------------	---	-----------------

5 FLUTES SQUARE-ALTN COATED



210-CID-SHH1250	ENDMILL-SQ-5FL-TIALN-1/8 (5045-22035)"	1	\$7.58
210-CID-SHH3125	ENDMILL-SQ-5FL-TIALN-5/16 (5045-22090)"	1	\$16.58



**CORNER RADIUS
VARIABLE HELIX ENDMILL
POWERPA**



64% OFF

Order #	Description	QTY	CLEARANCE
163-449-553-1	1/2X1-1/4X1/2X3 7FL .030	2	\$56.28
163-449-563-1	1/2X1-5/8X1/2X4 7FL .030	4	\$80.43
163-449-573-1	1/2X2X1/2X4 7FL .030	6	\$87.44



Warehouse CLEARANCE



Call: 905.624.5524

Email: sales@caliberindustrial.com

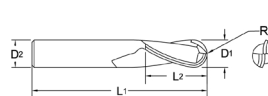

Solid Carbide Ball Nose End Mills - 2 Flute



	Order #	D1 x R	L2	L1	D2	QTY	SALE Price
STANDARD SHANK	109-220202-030X	3.0X1.5R	6	50	6	3	\$20.80
	109-220202-040AX	4.0X2.0R	8	50	4	3	\$18.88
	109-220202-040X	4.0X2.0R	8	50	6	3	\$20.80
	109-220202-060F	6.0X3.0R	12	50	6	1	\$20.80
	109-220202-070X	7.0X3.5R	14	60	8	2	\$39.04
	109-220202-080F	8.0X4.0R	16	60	8	1	\$39.04
	109-220202-080X	8.0X4.0R	16	60	8	1	\$39.04
	109-220202-090X	9.0X4.5R	18	72	10	1	\$60.80
LONG SHANK	109-220212-030X	3.0X1.5R	6	75	4	3	\$27.52
	109-220212-040F	4.0X2.0R	8	75	4	8	\$27.52
	109-220212-040X	4.0X2.0R	8	75	4	19	\$27.52
	109-220212-050AF	5.0AX2.5R	10	75	6	1	\$32.00
	109-220212-050AX	5.0AX2.5R	10	75	6	2	\$32.00
	109-220212-050X	5.0X2.5R	10	100	6	4	\$40.00
	109-220212-080X	8.0X4.0R	16	100	8	3	\$56.00

SOLID CARBIDE ENDMILL for ALUMINUM

ORDERING CODE	MANUFACTURER	SIZE	FLUTE #	COATING	QTY	CLEAROUT
121-500-5000-32	MRT	5/8x5/8x3/4x3	3	TiCN	2	\$65.00
300-WAR313A024030	UDIN	3/8x3/8x1x2-1/2, R0.030	3	BRIGHT	41	\$29.00
283-22213	SIEM TOOL (USA)	3/4x3/4x1-3/4x4	2	BRIGHT	1	\$89.00

CONTOUR360° 2 Flute Square - Standard Length

Order Number	Description	QTY	CLEARANCE PRICE
113-NC42024	3/8 X 3/8 X 7/8 X 2-1/2	1	\$15.45
2 Flute ALTiN Coated - Square Standard Length			
113-NC42020A	5/16 X 5/16 X 7/8 X 2-1/2	1	\$18.71
113-NC42036A	3/4 X 3/4 X 1-1/2 X 4	1	\$87.41
3 Flute TiCN Coated Square End Mill for Aluminum			
113-NC43050	1/8 X 1/8 X 1/4 X 1-1/2	2	\$9.08
113-NC43070	5/16 X 5/16 X 13/16 X 2-1/2	1	\$20.00
4 Flute Ballnose - Solid Carbide End Mill			
113-NC64008	1/8 X 1/8 X 1/2 X 1-1/2	1	\$5.00
4 Flute TiAlN Coated Ballnose Solid Carbide End Mill			
113-NC64020A	5/16 X 5/16 X 7/8 X 2-1/2	1	\$20.00
4 Flute Corner Radius TiCN, Standard Length W = WELDON FLAT			
113-NCM4143W-MOD	1X1X1-1/2X4 CORNER RAD MODIFIED SHANK	2	\$129.90
4 Flute Corner Radius Stub Length			
113-NCM1020	5/16 X 5/16 X 7/16 X 2.015-.020R	2	\$19.68
113-NCM1028	7/16 X 7/16 X 9/16 X 2-1/2.015-.020R	2	\$30.45
113-NCM1034	5/8 X 5/8 X 3/4 X 3.030-.035R	2	\$58.44
113-NCM1040	1 X 1 X 1-1/4 X 3.030-.035R	1	\$142.86
4 Flute Ball End, TiCN, Standard Length			
113-NCM6034	5/8 X 5/8 X 1-5/8 X 3-1/2	1	\$64.83
4 Flute Ball End, Stub Length			
113-NCM2011	5/32 4FL B/N STUB MULTIMILL	3	\$9.00
113-NCM2012	3/16 4FL B/N STUB MULTIMILL	4	\$10.92

DESTINY TOOL THE MARK OF PERFORMANCE

2 Flute Square & Ball End Aluminum & Non-Ferrous, Var.-Helix

Order Number	Description	QTY	CLEARANCE PRICE
103-V2080304S	VIPER 1/8, 2 FLT, 3/16 LOC, 1/2 LBS, 1-1/2 OAL, STEALTH COATING	3	\$10.90
103-V2321011S	VIPER 1/2, 2 FLT, 5/8 LOC, 1-3/8 LBS, 3 OAL, STEALTH COATING	6	\$45.58
103-V24012S	VIPER 5/8, 2 FLT, 3/4 LOC, 3-1/2 OAL, STEALTH	3	\$73.10
103-BV24012S	BALL VIPER 5/8, 2 FLT, 3/4 LOC, 3-1/2 OAL, STEALTH COATING	1	\$90.30
3 Flute Square End Aluminum & Non-Ferrous, Var.-Helix			
103-V30501	VIPER 5/64 DIA, 3 FLT, 7/64 LOC, 1/8 SHK, 1-1/2 OAL	1	\$21.60
103-V32008S	VIPER 5/16, 3 FLT, 1/2 LOC, 2 OAL, STEALTH COATING	2	\$24.37
103-V32013S	VIPER 5/16, 3 FLT, 13/16 LOC, 2-1/2 OAL, STEALTH COATING	1	\$32.73
4 Flute Square End General Purpose Steel, Var.-Helix			
103-R61606RC	RAPTOR 1/4, 3/6 FLT, 3/8 LOC, .015-.020 RAD, 2 OAL, ALTiN COATING	2	\$15.77
103-R62408C	RAPTOR 3/8, 3/6 FLT, 1/2 LOC, 2 OAL, ALTiN COATING	1	\$23.79
103-R62408RC	RAPTOR 3/8, 3/6 FLT, 1/2 LOC, .015-.020 RAD, 2 OAL, ALTiN COATING	8	\$26.09
103-R63210RC	RAPTOR 1/2, 3/6 FLT, 5/8 LOC, .025-.030 RAD, 3 OAL, ALTiN COATING	6	\$43.86
103-R63220RC	RAPTOR 1/2, 3/6 FLT, 1-1/4 LOC, .025-.030 RAD, 3 OAL, ALTiN COATING	2	\$49.88
3/8 Flute Square End Contouring Exotic Materials, Var.-Helix			
103-DVH405010RC	DVH 5/64 DIA, 4 FLT, 7/64 LOC, .005 RAD, 3/16 SHK, 2 OAL, ALTiN COATING	4	\$21.00
103-DVH43210RC	DVH 1/2, 4 FLT, 5/8 LOC, .025-.030 RAD, 3 OAL, ALTiN COATING	2	\$43.86
Diamond Back Roughers Heavy Aluminum Roughing, Var.-Helix			
103-DR3321011R030S	DBACK ROUGHER 1/2, 3 FLT, 5/8 LOC, .030 RAD, 1-3/8 LBS, 3 OAL, STEALTH COATING	1	\$61.35
103-DR34816R030S	DBACK ROUGHER 3/4, 3 FLT, 1 LOC, .030 RAD, 4 OAL, STEALTH COATING	1	\$123.26

INSERT CLEAROUT EVENT

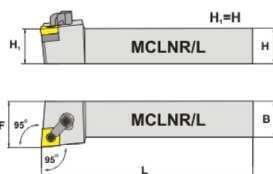

Right Hand Shown

KIT Content

1 HOLDER and 10 INSERTS
from LIST BELOW

**** Must Purchase 10 Inserts ****

KIT Price
\$119.00

EDP #	Description	Chipbreaker	Application	QTY	Manufacturer	Price
146-CNMA433VP1505	CNMA433-VP1505 HI-PERFORMANCE FOR CAST IRON	FLAT	CAST IRON	3	WALTER	\$3.99
135-11335509	CNMA434 (120416EN)-S CTC3110	FLAT	CAST IRON	9	CERATIZIT	\$3.99
136-122390	CNMA434 UC5005	FLAT	CAST IRON	2	MITSUBISHI	\$3.99
136-292787	CNMA544 UC5105	FLAT	CAST IRON	2	MITSUBISHI	\$3.99
129-5655473	CNMP431-3D SC3025/(MP23-NO HONE)	POSITIVE	STEEL P25	3	STELLRAM	\$3.99
117-6607045	CNMP432NN-LT10	POSITIVE	STEEL P20-P30	3	TECHNIKS	\$3.99
129-12936	CNMP433-3D-MP23M STELLRAM INSERT	POSITIVE	STEEL P10-P20	28	STELLRAM	\$3.99
146-CNMP433C59610	CNMP433-C5 9610 TURNING INSERT	POSITIVE	STEEL P10-P20	10	WALTER	\$3.99
135-11167338	CNMG 120408EN-M42 CTP2120	F	STEEL P15-P25	20	CERATIZIT	\$3.99
135-11167501	CNMG 120408EN-M52 CTP2120	M	STEEL P15-P25	34	CERATIZIT	\$3.99
135-11826631	CNMG 120408EN-M70 CTC125	R	STEEL P20-P30	25	CERATIZIT	\$3.99
135-11826656	CNMG 120412EN-M70 CTC125	R	STEEL P20-P30	10	CERATIZIT	\$3.99
146-6059742	CNMG431-FP5 WPP10S	F-M	STEEL P10-P20	18	WALTER	\$5.99
129-5651832	CNMG432A-4U SC1519	R	CAST IRON	11	STELLRAM	\$3.99
135-342497	CNMG432EN-TF GM537	F	STEEL P20-P30	8	CERATIZIT	\$3.99
135-11005501	CNMG432EN-TMF GM537	M	STEEL P20-P30	7	CERATIZIT	\$3.99
199-1-02-034692	CNMG432-HS PC8110	M	HI TEMP ALLOY	10	KORLOY	\$3.99
146-CNMG432LC515	CNMG432-LC 515	LOW CARBON	STEEL P20-P30	6	WALTER	\$3.99
146-CNMG432M28535	CNMG432-M2 8535 FOR HI-TEMP ALLOYS	F-M	HI-TEMP ALLOY	2	WALTER	\$3.99
146-6613404	CNMG432-MP3 WPP05S	F-M	STEEL P05	46	WALTER	\$5.99
146-6059692	CNMG432-MP3 WPP10S	F-M	STEEL P10	52	WALTER	\$5.99
336-CNMG120408MPCX2555	CNMG432-MP-CX2555 TURNING INSERT	F-M	STEEL P20-P25	20	WINSTAR/CARBIDEX TOOLS	\$3.99
336-CNMG120408MPCX2565	CNMG432-MP-CX2565 TURNING INSERT-MULTILAYER	F-M	STEEL P20-P25	40	WINSTAR/CARBIDEX TOOLS	\$3.99
146-7560025	CNMG432-MU5 WPP20S	M	STEEL P20-P25	30	WALTER	\$5.99
117-6608016	CNMG432NN-LT1000	M	STEEL P20-P25	15	TECHNIKS	\$3.99
117-6607033	CNMG432NN-LT10	M	STEEL P20-P25	20	TECHNIKS	\$3.99
336-CNMG120408RPCX2555	CNMG432-RP-CX2555 TURNING INSERT	R	STEEL P20-P25	30	WINSTAR/CARBIDEX TOOLS	\$3.99
336-CNMG120408RPCX2565	CNMG432-RP-CX2565 TURNING INSERT-MULTILAYER	R	STEEL P20-P30	50	WINSTAR/CARBIDEX TOOLS	\$3.99
286-CNMG432SFTX520	CNMG432-SF-TX520 COATED CERMET	F	STEEL P10-P20	30	SSANGYONG	\$3.99
336-CNMG120408SPCX2555	CNMG432-SP-CX2555 NEGATIVE TURNING INSERT	F	STEEL P20-P30	4	WINSTAR/CARBIDEX TOOLS	\$3.99
199-1-02-044833	CNMG432-VM NC3220	F-M	STEEL P20-P30	20	KORLOY	\$3.99
199-1-02-036484	CNMG432-VM PC5300	F-M	STEEL P20-P30	50	KORLOY	\$3.99
129-026704	CNMG433A-3J SP3036	M	ST/STL M20-30	3	STELLRAM	\$3.99
135-11224250	CNMG433EN-TM CTC1130	M-R	STEEL P20-P30	30	CERATIZIT	\$3.99
136-384905	CNMG433GH UE6110	R	STEEL P20-P30	1	MITSUBISHI	\$3.99
136-232004	CNMG433GJ VP15TF	R	STEEL P20-P30	10	MITSUBISHI	\$3.99
146-CNMG433M49605	CNMG433-M4-9605	M	STEEL P20-P30	3	WALTER	\$3.99
146-5092677	CNMG433-NM6 WPP20	M-R	STEEL P20-P30	10	WALTER	\$3.99
146-CNMG433R3VP1510	CNMG433-R3-VP1510 HI-PERFORMANCE FOR CAST IRON	R	CAST IRON	1	WALTER	\$3.99
140-CNMG433RBTP30	CNMG433-RB-TP30 COATED TURNING INSERT	R	STEEL P20-P30	9	VARDEX	\$3.99
135-11242705	CNMG543EN-909 CTC1130	M	STEEL P20-P30	4	CERATIZIT	\$5.99
136-497889	CNMG543MP UC5115	POS	CAST IRON	10	MITSUBISHI	\$5.99
140-CNMG643909LP2002	CNMG643-909-LP2002 COATED INSERT	R	STEEL P20-P30	10	VARDEX	\$6.99
140-CNMG643909LP4002	CNMG643-909-LP4002 ROUGHING INSERT	R	STEEL P20-P30	4	VARDEX	\$6.99
129-CNMG643A3SNTA	CNMG643A-3S NTA	1	STEEL P20-P30	7	STELLRAM	\$2.99
129-CNMG643A3ST14	CNMG643A-3S T14	1	STEEL P20-P30	10	STELLRAM	\$2.99
135-11171527	CNMG643EN-TMR CTC1125	R	STEEL P20-P30	10	CERATIZIT	\$6.99
116-JBMGR3MEAG535	CNMG643-ME AG535/525	R	STEEL P20-P30	3	TOOLFLO	\$6.99
129-5651691	CNMG644A-4T NL30	R	STEEL P20-P30	90	STELLRAM	\$6.99

* F= FINE, M= MEDIUM, R= ROUGHING *

Available While Supplies Last



Warehouse CLEARANCE



Call: 905.624.5524

Email: sales@caliberindustrial.com

DN Series INDEXABLE-TURNING-NEGATIVE INSERTS



DNNGP



DNMA



DNMG

ITEM NUMBER	DESCRIPTION	MANUFACTURER	CHIPBREAKER	APPLICATION	QTY	CLEARANCE
140-DNMG331903LP151	DNMG331-903-LP151 VERSA-TURN INSERT	VARDEX	F-M	STEEL P20-P30	9	\$3.99
140-DNMG331903LP242	DNMG331-903-LP242 VERSA-TURN INSERT	VARDEX	F-M	STEEL P20-P30	10	\$3.99
140-DNMG331903LP4002	DNMG331-903-LP4002 VERSA-TURN INSERT	VARDEX	F-M	STEEL P20-P30	10	\$3.99
140-DNMG332903LP151	DNMG332-903-LP151 VERSA-TURN INSERT	VARDEX	F-M	STEEL P20-P30	9	\$3.99
140-DNMG332903LP4002	DNMG332-903-LP4002 VERSA-TURN INSERT	VARDEX	F-M	STEEL P20-P30	10	\$3.99
129-027462	DNGP430.2-3F-SP4064	STELLRAM	FINE FINISH	STEEL FINISHING	17	\$7.99
146-6057718	DNMG431-FP5 WPP10S	WALTER	F-M	STEEL P10-P20	2	\$8.99
146-6065885	DNMG431-FP5 WPP20S	WALTER	F-M	STEEL P20-P30	1	\$8.99
136-347039	DNMG431C NX2525 INSERT	MITSUBISHI	F-M	STEEL FINISH-CERMET	10	\$5.99
135-11553194	DNMG431EN-M50 CTC125	CERATIZIT	M	STEEL P20-P30	3	\$7.99
136-101770	DNMG431MS HTI20T INSERT	MITSUBISHI	M	NON-FERROUS	4	\$4.99
136-437616	DNMG431SH NX3035 INSERT	MITSUBISHI	F	STEEL CTD-CERMET	4	\$7.99
146-6059697	DNMG432-MP3 WPP20S	WALTER	F-M	STEEL P20-P30	10	\$8.99
146-7271200	DNMG432-MV5 WPV20	WALTER	M	STEEL P20-P30	8	\$5.99
146-6113797	DNMG432-RP5 WPP10S	WALTER	R	STEEL P10-P20	2	\$8.99
199-1-02-039830	DNMG432-VM PC5300	KORLOY	M	STEEL P20-P30	8	\$7.99
135-11168410	DNMG432EN-M42 CTC2135	CERATIZIT	F-M	STEEL P20-P30	15	\$7.99
135-11513923	DNMG432EN-M50 CTC125	CERATIZIT	M	STEEL P20-P30	2	\$7.99
136-116712	DNMG432GH UE6005 INSERT	MITSUBISHI	R	STEEL P05-P10	2	\$5.99
136-191118	DNMG432GH UE6020 INSERT	MITSUBISHI	R	STEEL P20-P30	1	\$5.99
136-116295	DNMG432GH UE6035 INSERT	MITSUBISHI	R	STEEL P30-P40	2	\$5.99
136-155408	DNMG432GH US7020 INSERT	MITSUBISHI	R	STAINLESS M25	2	\$5.99
136-101832	DNMG432GH US735 INSERT	MITSUBISHI	R	STAINLESS M35	12	\$5.99
136-198281	DNMG432GJ RT9010 INSERT	MITSUBISHI	M	EXOTIC-M10	7	\$5.99
136-198176	DNMG432GJ VP10RT INSERT	MITSUBISHI	M	EXOTIC-M10	2	\$5.99
136-602423	DNMG432LP MP3025 INSERT	MITSUBISHI	L-M	STEEL P20-P30	7	\$5.99
136-174351	DNMG432MA UE6020 INSERT	MITSUBISHI	M	STEEL P20-P30	2	\$5.99
336-DNMG150408MGCX2555	DNMG432MG-CX2555 TURNING INSERT	CARBIDEX TOOLS	M	STEEL P20-P30	40	\$5.99
336-DNMG150408MGCX2565	DNMG432MG-CX2565 TURNING INSERT	CARBIDEX TOOLS	M	STEEL P20-P30	20	\$5.99
136-259792	DNMG432MJ RT9010 INSERT	MITSUBISHI	M-F	EXOTIC-M20	10	\$5.99
336-DNMG150408RGCX2555	DNMG432RG-CX2555 TURNING INSERT	CARBIDEX TOOLS	R	STEEL P20-P30	10	\$5.99
136-384681	DNMG432SA UE6110 INSERT	MITSUBISHI	F	STEEL P10-P20	2	\$5.99
136-155272	DNMG432SA US7020 INSERT	MITSUBISHI	F	STAINLESS P20-P30	2	\$5.99
146-6113798	DNMG433-RP5 WPP10S	WALTER	R	STEEL P10-P20	30	\$8.99
135-11167270	DNGP440.5FN-F32 CTP2120	CERATIZIT	FINE FINISH	STEEL P10-P20	10	\$7.99
135-11167271	DNGP441FN-F32 CTP2120	CERATIZIT	FINE FINISH	STEEL P10-P20	18	\$7.99
149-146-300	DNMG442-D10 PT20C CARBIDE INSERT	SOWA	F	STEEL P20-P30	5	\$5.99
129-5654940	DNMG442A-4T NL30	STELLRAM	R	STEEL P20-P30	20	\$5.99
135-11355944	DNMG442EN-M34 CTP5115	CERATIZIT	M	STEEL P05-P10	9	\$5.99
136-394290	DNMG442MS US735 INSERT	MITSUBISHI	M	STAINLESS M35	10	\$5.99
136-483276	DNMG442MV UE6105	MITSUBISHI	M	STEEL P05-P10	7	\$5.99
136-394417	DNMG443MJ US905 INSERT	MITSUBISHI	M	HI-TEMP ALLOY	4	\$5.99

DN Series APPLICABLE TOOLHOLDERS

ITEM NUMBER	DESCRIPTION	MANUFACTURER	APPLICATION	QTY	CLEARANCE
286-EGML130	MDJNR-164D TOOLHOLDER	ECO-TURN	MULTI-CLAMP	3	\$79.00

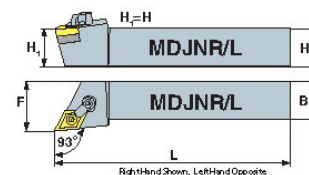

TPG/TPMN/TPMR/TPU**CARBIDE INSERTS**

TPMT

TPG
TPMN
TPU

Item Number	Designation	Manufacturer	Application	QTY	CLEARANCE
136-108340	TPG-220.5-NX55 CERMET-UNCOATED	MITSUBISHI	TURNING/MILLING	13	\$2.99
136-108368	TPG-320.5-NX55 CERMET-UNCOATED	MITSUBISHI	TURNING/MILLING	30	\$2.99
129-5655505	TPG-322-HA C2 UNCOATED	TELEDYNE	TURNING NON-FERROUS	10	\$0.99
214-FF5022860	TPG-322-PC200 C2 AL-OXIDE COATED	PROCUT	MILLING/TURNING	10	\$1.99
180-TPG322XL85	TPG-322-XL85 CERMET-UNCOATED	EXCELLO	MILLING/TURNING	11	\$1.99
180-TPG322XL86	TPG-322-XL86 CERMET-UNCOATED	EXCELLO	MILLING/TURNING	10	\$1.99
135-11404378	TPG-432-N55 C5 UNCOATED CARBIDE	NEWCOMER	MILLING/TURNING	10	\$2.99
146-TPG432T00515Q32	TPG-432T00515-Q32 CERAMIC	VALENITE	TURNING HH STEEL	6	\$3.99
136-108508	TPMN-321-NX55 CERMET-UNCOATED	MITSUBISHI	MILLING/TURNING	10	\$2.99
136-108512	TPMN-321-UT120T C5 UNCOATED CARBIDE	MITSUBISHI	MILLING/TURNING	10	\$2.99
136-108572	TPMN-431-UT120T C5 UNCOATED CARBIDE	MITSUBISHI	MILLING/TURNING	2	\$0.99
136-108584	TPMN-432-UP20M CS COATED CARBIDE	MITSUBISHI	MILLING/TURNING	1	\$0.99
136-108600	TPMN-433-UT120T C5 UNCOATED CARBIDE	MITSUBISHI	MILLING/TURNING	10	\$2.99
136-108610	TPMN-434-UT120T C5 UNCOATED CARBIDE	MITSUBISHI	MILLING/TURNING	20	\$2.99
129-TPU434NTA	TPU-434-NTA C5 UNCOATED CARBIDE	TELEDYNE	MILLING/TURNING	20	\$1.99
149-146-665	TPMR-322-M PT20C COATED CARBIDE	SOWA	TURNING	2	\$1.99



**PARTING INSERTS
GTN STYLE**

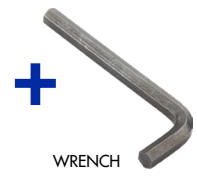
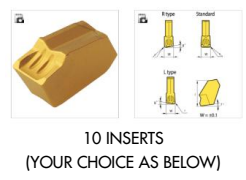

**PACKAGE DEAL
\$89.00**

ITEM NUMBER	MANUFACTURER	DESIGNATION	WIDTH	LEAD ANGLE	QTY	CLEARANCE **Inserts Only**
180-COL8120BP656	BELCAR(USA)	COL(8)-120-BP656	3mm(.120)	8 degree Left	50	\$4.99
180-COL8120BP54C	BELCAR(USA)	COL(8)-120-BP54C			9	\$4.99
180-COR8120BP656	BELCAR(USA)	COR(8)-120-BP656	3mm(.120)	8 degree Right	26	\$4.99
135-11401721	CERATIZIT	NGTR-3-8-PV52			3	\$4.99

GROOVING INSERTS

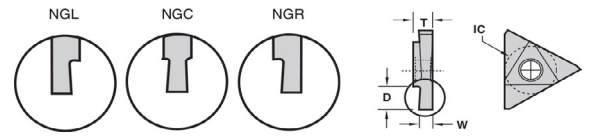
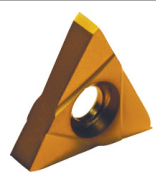

Item Number	Manufacturer	Designation	Width	Lead Angle	QTY	CLEARANCE
116-0253050N4C	TOOL FLO Member IMC Group	TNMC54 NT 5P GP50C	5ACME	29 Degree	5	\$4.99
116-0211100AT3		TPMC 32 NT 10P AT3	10ACME	29 Degree	2	\$4.99
136-107388	MITSUBISHI MATERIALS U.S.A.	TNMC43NGR094 UP20M INSERT	.094	Neutral	6	\$4.99
146-TNMC43NGR1255	WALTER	TNMC43NGR125 VC5 UNCOATED INSERT	.125	Neutral	5	\$4.99
180-TNMC43NGRW100AN2	CALIBER INDUSTRIAL SUPPLY	TNMC43NGR-W.100-AN2 UNCOATED INSERT (ANC CARBIDE)	.100	Neutral	20	\$4.99
180-TNMC43NGRW125AN66		TNMC43NGR-W.125 AN66 UNCOATED INSERT (ANC CARBIDE)	.125	Neutral	67	\$4.99
180-TPMC32NVAN6		TPMC-32NV-AN6 UNCOATED CARBIDE (ANC CARBIDE)	THREAD	60 Degree	10	\$4.99
180-TPMC32NVAN66		TPMC 32NV AN-66 UNCOATED INSERT (ANC CARBIDE)	THREAD	60 Degree	18	\$4.99
180-TPMC32NGLW098AN2		TPMC-32NGL-W.098-AN2 UNCOATED CARBIDE INSERT (ANC CARBIDE)	.098	Neutral	10	\$4.99
180-TPMC43NGRW126AN2		TPMC-43NGR-W.126-AN2 UNCOATED CARBIDE INSERT (ANC CARBIDE)	.126	Neutral	30	\$4.99
180-TPMC54NGRW1875AN66		TPMC-54NGR-W.1875 AN66 UNCOATED CARBIDE (ANC CARBIDE)	.1875	Neutral	3	\$4.99
180-TPMC54NGRW250AN66		TPMC-54NGR-W.250-AN66 UNCOATED CARBIDE (ANC CARBIDE)	.250	Neutral	5	\$4.99



CLEARANCE - Parting + Grooving

Buy 10 Inserts and Get
The Blade for **FREE**

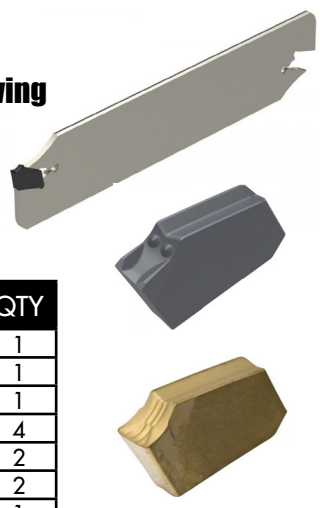

HOLDER Order#	Description	QTY
135-195627	MSS-E20R20-FX2.2	1
135-11013312	XLCEN 3202 M22 FX	1
135-154280	XLCFN 2603 J31 FX	1
135-154282	XLCFN 2604 J41 FX	4
135-154284	XLCFN 3203 M31 FX	2
135-154285	XLCFN 3204 M41 FX	2
135-154273	XLCFR 2520 M31 FX	1

INSERT Order#	Description	QTY	CLEARANCE
135-11040967	FX 3.1L5-F1 GM740	5	\$8.99
135-11040988	FX 3.1L5-F1 SR735	55	\$8.99
135-154420	FX 3.1L6-M1 SR127	10	\$8.99
135-11040666	FX 3.1L6-M1 SR735	10	\$8.99
135-11348356	FX 3.1N0.15-M1 CTC1325	8	\$8.99
135-11719838	FX 3.1N0.15-M1 CTCP335	25	\$8.99
135-11267988	FX 3.1N0.15-M1 CTP1340	19	\$8.99
135-153846	FX 3.1N0.15-M1 S40T	10	\$8.99
135-154253	FX 3.1N0.15-M1 SR127	10	\$8.99
135-11040667	FX 3.1N0.15-M1 SR735	10	\$8.99
135-11348362	FX 3.1N0.20-F1 CTP1340	20	\$8.99
135-11724098	FX 3.1N0.20-F1 CTPP345	10	\$8.99
135-11041166	FX 3.1N0.40-R2 SR735	18	\$8.99
135-11040964	FX 3.1R5-F1 GM740	5	\$8.99
135-11039079	FX 4.1N0.20-F1 GM740	15	\$8.99
135-11724538	FX 4.1N0.20-M1 CTPP345	10	\$8.99
135-11040991	FX 4.1R5-F1 GM740	10	\$8.99

Item Number	Designation	Manufacturer	Application	QTY	CLEARANCE
146-23550	VLG 2 125L 5310	Valenite	GROOVING AND THREADING (DISCONTINUED)	5	\$6.99
146-23396	VLG 3 062R 5820			6	\$8.99
146-23021	VLG 3 094R 5735			5	\$8.99
146-23036	VLG 3 110R 5735			15	\$8.99
146-23041	VLG 3 125R 5735			5	\$8.99
146-23415	VLG 3 125R 5820			5	\$8.99
146-23467	VLR 3 062R 5320			15	\$8.99
146-23596	TGEB 3.52 NGM L125			GROOVING	10
230-ISC6003399	DGN 3102J IC907	Isenf	GROOVE-TURN	10	\$12.99
214-EH6002500	GFN 2 GRADE IC328		10	\$9.99	
149-800-164	150.10-4N-16 T25M	Seco	PARTING OFF	10	\$9.99
180-150.10-5N16HX	150.10-5N-16 HX			10	\$9.99
136-101641	DGM40CTF US735	MITSUBISHI MATERIALS	GROOVE-TURN	15	\$9.99
149-146-836	MGMN500-M PT20C	SOWA TOOLING YOUR WORLD.		3	\$9.99
149-147-293	MGMN800-M PT20C			3	\$9.99

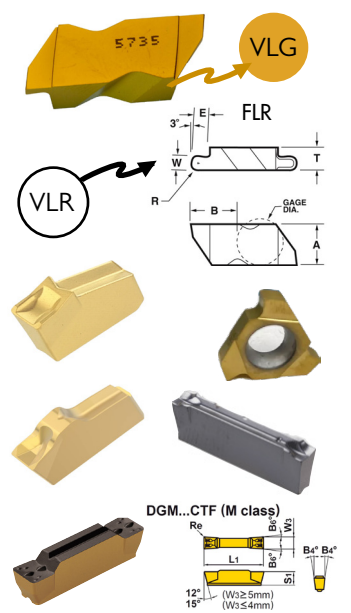



PC3500



PC5300

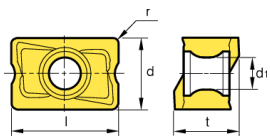

KIT#1 Includes:

- Holder
 199-1-06-016565 ----- RM4PSA3100HR-S100M - **QTY:1** ----- **\$189.00**
 1 piece RM4PSA3100HR-S100M and 10 LNMX100605PNR-MM PC3500 ----- \$199.00
 1 piece RM4PSA3100HR-S100M and 10 LNMX100605PNR-MM PC5300 ----- \$299.00

- Associated Inserts
 199-1-02-033503 ----- LNMX100605PNR-MM PC3500 (Gold) - **QTY:10** ----- \$10.99
 199-1-02-036973 ----- LNMX100605PNR-MM PC5300 (Black) - **QTY:10** ----- \$19.26

KIT#2 Includes:

- Holder
 199-1-06-013041 ----- RM4PSA4150HR-S125 - **QTY:1** ----- **\$269.00**
 1 piece RM4PSA4150HR-S125 and 20 LNMX151008PNR-MM PC3500 ----- \$299.00
 1 piece RM4PSA4150HR-S125 and 20 LNMX151008PNR-MM PC5300 ----- \$499.00

KIT#3 Includes:

- Holder
 199-1-06-012639 ----- RM4PCA4200HR - **QTY:2** ----- **\$289.00**
 1 piece RM4PCA4200HR and 20 LNMX151008PNR-MM PC3500 ----- \$319.00
 1 piece RM4PCA4200HR and 20 LNMX151008PNR-MM PC5300 ----- \$529.00

KIT#4 Includes:

- Holder
 199-1-06-012643 ----- RM4PCA4300HR - **QTY:1** ----- **\$499.00**
 1 piece RM4PCA4300HR and 20 LNMX151008PNR-MM PC3500 ----- \$399.00
 1 piece RM4PCA4300HR and 20 LNMX151008PNR-MM PC5300 ----- \$549.00
- Associated Inserts
 199-1-02-033505 ----- LNMX151008PNR-MM PC3500 - **QTY:20** ----- \$12.99
 199-1-02-037092 ----- LNMX151008PNR-MM PC5300 - **QTY:20** ----- \$23.84



KORLOY
BLOWOUT CLEARANCE

KIT Price: \$449.00

Use Insert #: APKT1604
 Cutter Diameter: 4.000"
 Arbor Hole Diameter: 1.250"

6 Kits
 ONLY Available!

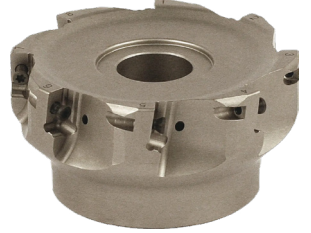

QTY	Order#	Description
40	336-APKT160408PDERMGCX32HS	APKT-160408PDER-MG-CX32HS MILLING INSERT
1	199-1-06-021244	AMCA3400HS (8 FLUTES)

** 8-Tooth Cutter - Coarse Pitch
 ** Most Suitable for CAT50 Machines



**** Inserts Below for Cutter Style Shown! ****

SE__ - 42 (1203) (.500 x .125 THICK)

Item Number	Description	QTY	CLEARANCE
149-146-322	SECN - 1203AFTN-CN 30 (CERMET)	10	\$4.99
149-146-340	SEK 42AFTN PM25C	2	\$1.99
136-104701	SEEN42EFER1 UP20M (15° Lead-Roughing ONLY)	10	\$1.99
336-SEMR1203AFSNRGCX32HS	SEMR-1203AFSN-RG-CX32HS	70	\$7.99

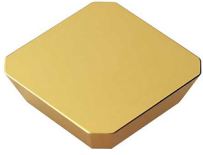

SE__ - 43 (1204) (.500 x .187 THICK)

Item Number	Description	QTY	CLEARANCE
180-SEC432FT2	SECN 432 FT2 INSERTS	4	\$4.99
180-SEC43A4AT52	SECN 43A4 AT52 INSERTS	4	\$4.99
146-SEER43AFERV1N	SEER43AFER VIN TIN COATED INSERT	10	\$4.99
146-SEHN43AFSN35M	SEHN43AFSN 35M UNCOATED INSERT	10	\$4.99
146-SEHN43AFTN935	SEHN43AFTN 935 TIN COATED INSERT-NO HOLE	10	\$4.99
149-146-360	SEK43AFTN PTM30U CARBIDE	50	\$4.99
136-104826	SEMN43AZEN F620 COATED MILLING INSERT	5	\$4.99
136-104830	SEMN43AZTN UP20M COATED MILLING INSERT	7	\$4.99
136-104831	SEMN43AZTN UTI20T UNCOATED CARBIDE INSERT	20	\$4.99



FMACA4000

HURRY! Only 2 CUTTERS Left!

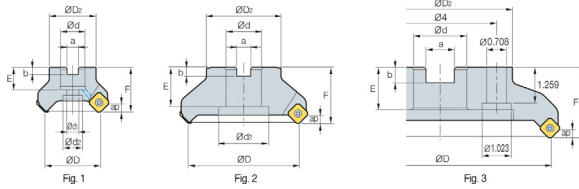

Buy 40 inserts & GET FREE CUTTER!

SEXT-MM Designation Coated
PC5300

SEXT 14M4AGSN-MM ●

Order #: 199-1-02-037108 ***PRICE: \$21.80***

AA 45° • AR: 21°
• RR: -17°~-12°
Order #: 199-1-06-009111

Designation	No. of Inserts	ØD	ØD2	Ød	α	b	E	F	Ød1	Ød2	ap	lbs
FMACA 4600R	7	6.0	4.882	2.00	0.750	0.433	1.181	2.50	-	-	0.256	10.6



VALUE \$539.00!

SAVE 66% BY PURCHASING A KIT!

****ONLY ONE Left at CLEAROUT****

QTY	Order #	MFG	Description	KIT PRICE
1	149-146-739	SOWA	2.0" ESFM 4200R - 4 FLUTE 45° FACEMILL	\$199.00
10	336-SEKT1204RGCX31NA	WINSTAR	SEKT-1204AFTN-RG-CX31NA MILLING INSERT	

MITSUBISHI MATERIALS U.S.A.

Item #	Designation	QTY	CLEARANCE
136-108452	TPKN32PPR-UTi20T C5 UNCOATED CARBIDE	10	\$ 2.99



Warehouse CLEARANCE

**KORLOY Has Discontinued Boxed Kits
First Come - First Served!**

KIT #	Order #	Description	QTY	List Price \$U.S.	CLEARANCE \$CAN
1	199-1-09-022629	AMCA3300HS-EXP KIT <u>1</u> 1-09-022629 3.00" x 7-Flute FACEMILL - 90° <u>10</u> 1-02-038374 APMT1604PDSR-MM PC5300	1	\$946.79	\$399.00
2	199-1-09-022641	AMSA2100HS-EXP KIT <u>1</u> 1-09-022641 1.00" - 3-Flute ENDMILL - 90° <u>10</u> 1-02-037089 APMT11T3PDSR-MM PC5300	1	\$395.10	\$189.00
3	199-1-09-022646	AMSA3150HS-EXP KIT <u>1</u> 1-09-022646 1.50" - 4-Flute ENDMILL - 90° <u>10</u> 1-02-038374 APMT1604PDSR-MM PC5300	1	\$611.75	\$249.00
4	199-1-09-022689	HRMDSA06075HR-2S075-EXP KIT <u>1</u> 1-09-022689 0.750" - 2-Flute FEEDMILL <u>10</u> 1-02-042197 WNMX060312ZNN-MM PC5300	1	\$581.51	\$249.00
5	199-1-09-022691	HRMDSA06100HR-3S100-EXP KIT <u>1</u> 1-09-022691 1.00" - 3-Flute FEEDMILL <u>10</u> 1-02-042197 WNMX060312ZNN-MM PC5300	2	\$620.74	\$249.00
6	199-1-09-022694	HRMDSA09100HR-2M100-EXP KIT <u>1</u> 1-09-022694 1.00" - 2-Flute FEEDMILL <u>10</u> 1-02-036423 WNMX09T316ZNN-MM PC5300	1	\$620.86	\$249.00
7	199-1-09-023088	RM3PSA3125HR-4L125 KIT <u>1</u> 1-09-023088 1.25 x 1.25 x 7.874 OAL x 4-Flute <u>10</u> 1-02-054253 XNKT060405PNSR-MM PC5300	2	\$484.20	\$199.00



KITS# 1



KITS# 2, 3, 4, 5, 6



KIT# 7

KITS CUTTER LINEUP ▶▶▶



AMCA3300HS



AMSA2100HS
AMSA3150HS



HRMDSA06075HR-2S075
HRMDSA06100HR-3S100
HRMDSA09100HR-2M100

****Each kit includes 1 cutter and 10 inserts, wrench, grease and literature.**

INDEXABLE MILLING



"THE BEAST" FOR HEAVY-DUTY FACE MILLING
MITSUBISHI/MOLDINO OVERSTOCK-ASDF DOUBLE-SIDED FEEDMILL

Kit Contents			Our Unbeatable PRICE
1ea	136-62046183	IASDF5040R-4U CUTTER BODY-2.5"x4FL	SEPARATE PIECE VALUE: \$1,377.31 ★ KIT PRICING ★ OVERSTOCK SALE: \$679.00
10ea	136-62011952	SNMU1607EN-B JP4120 MILLING INSERT	
OR			
10ea	136-62011969	SNMU1607EN-B JM4160 MILLING INSERT	
1ea	136-62046190	IASDF5048R-4U CUTTER BODY-3.0"x4FL	SEPARATE PIECE VALUE: \$1,460.98 ★ KIT PRICING ★ OVERSTOCK SALE: \$729.00
10ea	136-62011952	SNMU1607EN-B JP4120 MILLING INSERT	
OR			
10ea	136-62011969	SNMU1607EN-B JM4160 MILLING INSERT	
1ea	136-62046206	IASDF5064R-5U CUTTER BODY-4.0"x5FL	SEPARATE PIECE VALUE: \$1,685.44 ★ KIT PRICING ★ OVERSTOCK SALE: \$839.00
10ea	136-62011952	SNMU1607EN-B JP4120 MILLING INSERT	
OR			
10ea	136-62011969	SNMU1607EN-B JM4160 MILLING INSERT	

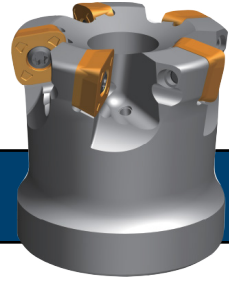

MOLDINO TR4D OVERSTOCK/CLEARANCE
 The Edge To Innovation



Kit Contents			Our Unbeatable PRICE
1ea	136-62098540	TR4D4032B-5 - 2.0" X 5 FLUTE CUTTER BODY-FEEDMILL	REGULAR PRICE: \$1,527.68 KIT PRICING: \$1,161.46 ★ OVERSTOCK PRICE: \$749.00 ★ SAVE \$778.68 (51%)
30ea	136-62079785	SDNW 120520TR-JP4120 - FEEDMILL INSERT	

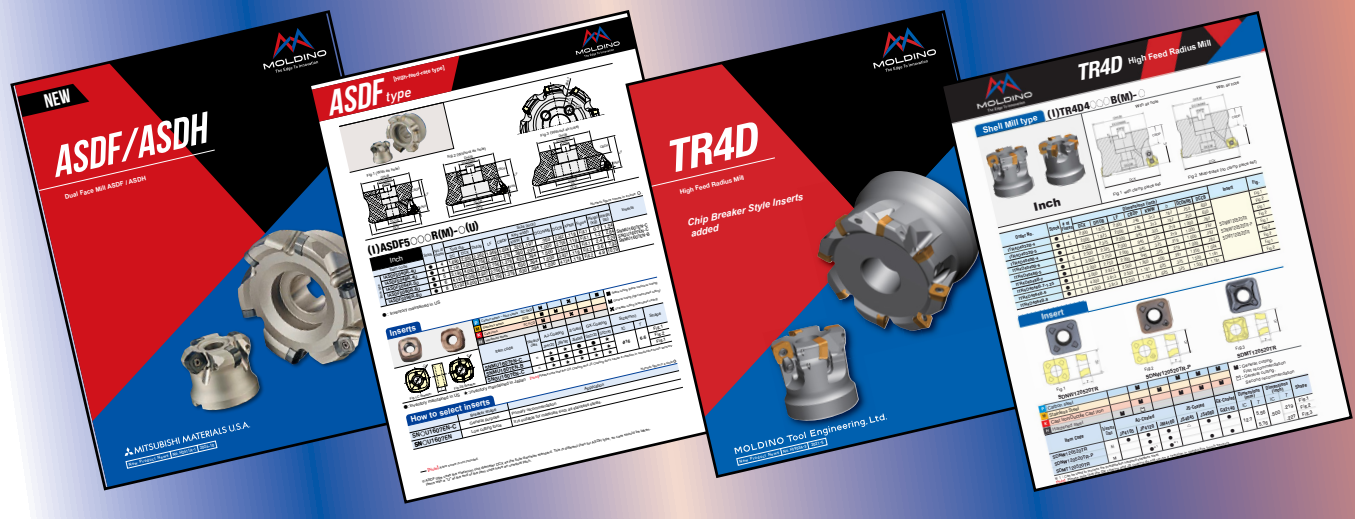

CHAMFER CUTTERS CLEARANCE

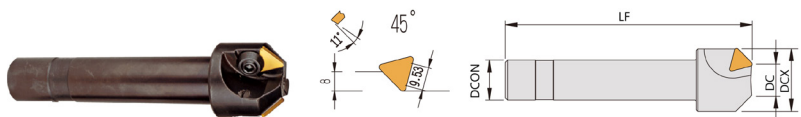

CALIBER EDP#	DESCRIPTION	QTY	KIT PRICE
254-ME05C	ME-05C 1-1/4" X 3/4" - 82 DEG - 1-FLUTE	1	\$99.00 + 10 Inserts
180-CH30500	CH30-500 1-1/4" X 3/4" - 60 DEG - 1-FLUTE (Min Dia - 1/2")	2	\$99.00 + 10 Inserts
214-FF5022860	TPG 322 PC200	10	ASSOCIATED CLEARANCE INSERTS
180-TPG322XL85	TPG 322 XL85	11	
180-TPG322XL86	TPG 322 XL86	10	

INDEXABLE CHAMFER TOOLS CLEARANCE



CALIBER EDP#	DESCRIPTION	QTY	LIST PRICE		
137-577-421	CC182 3/4" X 82 DEG	1	\$317.97	COUNTERSINK CHAMFER TOOL	KIT PRICE INCLUDING 1 CUTTER AND 10 INSERTS ** ONLY \$149.00 ** Value \$399.00
291-112-1836-54	TCMT 16T304 MP PH6910	10	\$4.99	ASSOCIATED CLEARANCE INSERTS	
135-11529822	TCMT 16T304EN-SF CTCP125	2	\$4.99	ASSOCIATED CLEARANCE INSERTS	

Do You Mill Exotic Materials?



WSRP ROUND POSITIVE END MILL

Applicable Insert

****** RPGN - 2.52 (ISO: RPGN - 070300)

Value
\$299.00
CLEARANCE
\$99.00

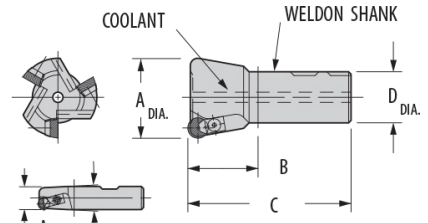

Right-Hand Cutter Shown

RIGHT HAND	GAGE INSERT	A	B	C	D	NO. OF INSERTS
Order# 400-1120293 WSRP-60000.7-RH	RPGN-2.52	0.750	1.250	3.280	0.750	2

Inserts	Part Number ANSI	Steel		Stainless Steel		Cast Iron		Heat-Resistant Super Alloys			Hardened Steel			Part Number ISO	Dimensions (inches)				
		P		M		K		S			H				A	T			
		GA5036	G-915	G-9120	G-915	G-9230	WG-600®	G-9230	G-915	GSN100™	XSYTIN®-1	G-915	G-9230				WG-600®	WG-300®	XSYTIN®-1
	RPGN-21.5	◆	▲	●	▲	◆	◆	◆	▲	◆	▲	◆	◆	●	◆	▲	RPGN-060200	0.250	0.094
	RPGN-2.52 **	◆	▲	●	▲	◆	◆	◆	▲	◆	▲	◆	◆	●	◆	▲	RPGN-070300	0.312	0.125
	RPGN-32	◆	▲	●	▲	◆	◆	◆	▲	◆	▲	◆	◆	●	◆	▲	RPGN-090300	0.375	0.125
	RPGN-43	◆	▲	●	▲	◆	◆	◆	▲	◆	▲	◆	◆	●	◆	▲	RPGN-120400	0.500	0.187

CARBIDE COATINGS: MT-CVD Coated PVD Coated Uncoated First Choice ◆ Second Choice ● Alternative ▲
 CERAMIC CLASSIFICATION: Whisker Ceramic Phase-Toughened Silicon Nitride Alumina TiC



WSRN ROUND NEGATIVE END MILL

Applicable Insert - 135-11281167

****** RNGN - 090300 - CTS31X CERAMIC

Value
\$299.00
CLEARANCE
\$99.00

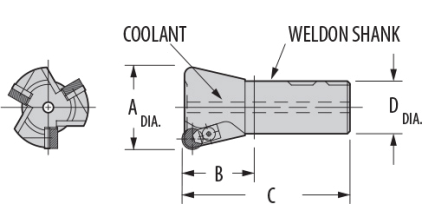

Right-Hand Cutter Shown

RIGHT HAND	GAGE INSERT	A	B	C	D	NO. OF INSERTS
Order# 400-1090146 WSRN-60001.2-RH	RNGN-32	1.250	1.250	3.530	1.000	3

Inserts	Part Number ANSI	Steel		Stainless Steel		Cast Iron		Heat-Resistant Super Alloys			Hardened Steel			Part Number ISO	Dimensions (inches)				
		P		M		K		S			H				A	T			
		GA5036	G-915	G-9120	G-915	G-9230	WG-600®	G-9230	G-915	GSN100™	XSYTIN®-1	G-915	G-9230				WG-600®	WG-300®	XSYTIN®-1
	RNGN-32 **	◆	▲	●	▲	◆	◆	◆	▲	◆	▲	◆	◆	●	◆	▲	RNGN-090300	0.375	0.125
	RNGN-42	◆	▲	●	▲	◆	◆	◆	▲	◆	▲	◆	◆	●	◆	▲	RNGN-120300	0.500	0.125
	RNGN-43	◆	▲	●	▲	◆	◆	◆	▲	◆	▲	◆	◆	●	◆	▲	RNGN-120400	0.500	0.187
	RNGN-45	◆	▲	●	▲	◆	◆	◆	▲	◆	▲	◆	◆	●	◆	▲	RNGN-120700	0.500	0.313

CARBIDE COATINGS: MT-CVD Coated PVD Coated Uncoated First Choice ◆ Second Choice ● Alternative ▲
 CERAMIC CLASSIFICATION: Whisker Ceramic Phase-Toughened Silicon Nitride Alumina TiC

PRODUCT CODE	BRAND	DESCRIPTION	QTY	OVERSTOCK	ILLUSTRATION
--------------	-------	-------------	-----	-----------	--------------

ENDMILL HOLDERS

149-531-072	SOWA	CAT40 3/16-1.38 ENDMILL	1	\$49.00	
149-531-006		CAT40-5/16-1.38 ENDMILL	1	\$49.00	
149-531-012		CAT40-3/8-1.38 ENDMILL	1	\$49.00	
149-531-014		CAT40-3/8-2.50 ENDMILL	1	\$49.00	
117-CAT40XSLN1/2-1.75	TECHNIKS	CAT 40 X SLN 1/2 - 1.75" GL W/DUAL DRIVE & COOL BLAST	3	\$99.00	
248-CAT40-EM050-0175-B	PIONEER	CAT40-1/2X1.75" ENDMILL HOLDER DUAL CONTACT	1	\$99.00	
248-CAT40-EM050-0600-B		CAT40-1/2X6" ENDMILL HOLDER DUAL CONTACT	1	\$149.00	
117-CAT40XSLN3/4X1.75	TECHNIKS	CAT 40 X SLN 3/4 - 1.75 GL W/DUAL DRIVE COOL BLAST	3	\$99.00	

COLLET CHUCK-ER

417-CAT40ER1670	ECO HOLD	CAT40-ER16-70 (2.76") ER COLLET CHUCK - BALANCED TO G2.5 15,000 RPM	4	\$49.99	
417-CAT40ER16100		CAT40-ER16-100 ER COLLET CHUCK - BALANCED TO G2.5 15,000 RPM	3	\$49.99	
417-CAT40ER20100		CAT40-ER20-100 ER COLLET CHUCK - BALANCED TO G2.5 15,000 RPM	5	\$49.99	
417-CAT40ER2570		CAT40-ER25-70 ER COLLET CHUCK - BALANCED TO G2.5 15,000 RPM	5	\$49.99	
417-CAT40ER25100		CAT40-ER25-100 ER COLLET CHUCK - BALANCED TO G2.5 15,000 RPM	10	\$49.99	
417-CAT40ER3270		CAT40-ER32-70 (2.76") ER COLLET CHUCK - BALANCED TO G2.5 15,000 RPM	7	\$49.99	
417-CAT40ER32100		CAT40-ER32-100 ER COLLET CHUCK - BALANCED TO G2.5 15,000 RPM	5	\$49.99	
417-CAT40ER32150		CAT40-ER32-150 ER COLLET CHUCK - BALANCED TO G2.5 15,000 RPM	2	\$59.99	
417-CAT40ER40100		CAT40-ER40-100 ER COLLET CHUCK - BALANCED TO G2.5 15,000 RPM	2	\$49.99	

COLLET CHUCK-HI PRECISION ER

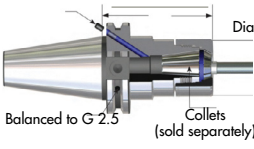
417-CAT40HGER1675	ECO HOLD	CAT40-HGER16-75 HGER COLLET CHUCK - BALANCED TO G2.5@25,000 RPM	6	\$99.99	
417-CAT40HGER1690		CAT40-HGER16-90 HGER COLLET CHUCK - BALANCED TO G2.5@25,000 RPM	5	\$99.99	
417-CAT40HGER2075		CAT40-HGER20-75 HGER COLLET CHUCK - BALANCED TO G2.5@25,000 RPM	5	\$99.99	
417-CAT40HGER2575		CAT40-HGER25-75 HGER COLLET CHUCK - BALANCED TO G2.5@25,000 RPM	5	\$99.99	
417-CAT40HGER2590		CAT40-HGER25-90 HGER COLLET CHUCK - BALANCED TO G2.5@25,000 RPM	5	\$99.99	
231-CV40ER3265HSBB	ERI	CAT40-ER32 X 65MM C/W HI-SPEED B/BRG NUT	1	\$99.99	
417-CAT40HGER3275	ECO HOLD	CAT40-HGER32-75 HGER COLLET CHUCK - BALANCED TO G2.5@25,000 RPM	5	\$99.99	
417-CAT40HGER3290		CAT40-HGER32-90 HGER COLLET CHUCK - BALANCED TO G2.5@25,000 RPM	10	\$99.99	
417-CAT40HGER32150		CAT40-HGER32-150 HGER COLLET CHUCK - BALANCED TO G2.5@25,000 RPM	3	\$99.99	

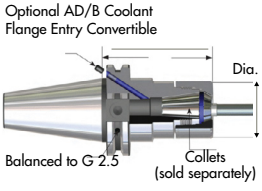

SHRINK FIT

149-531-862	SOWA	CAT40 3/4-3.15 SHRINK FIT HOLDER	1	\$129.00	
-------------	------	----------------------------------	---	----------	---

MILL CHUCKS (Made in JAPAN)

169-74304053	PARLEC	C40 HPC MILL CHUCK 3/4" X 4.13" (CV40-HPC075-105A)	1	\$399.00	
169-74304031		C40 HPC MILL CHUCK 1" X 5.31" (CV40-HPC100-135A)	1	\$399.00	

MOLD CHUCKS (Made in JAPAN)

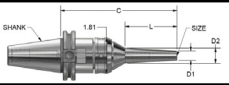
169-74304091	PARLEC	C40 HPC MOLD CHUCK 3/8" X 5.90" (CV40-HPC0375M-150)	1	\$499.00	
169-74304095		C40 HPC MOLD CHUCK 1/2" X 5.90" (CV40-HPC0500M-150)	1	\$499.00	

COLLET CHUCK-PULL COLLET-SLIM NOSE

248-CAT40-MX08-120	PIONEER	CAT40-MX08X4.72" MINI COLLET CHUCK	1	\$249.00	
--------------------	---------	------------------------------------	---	----------	---

SHELL MILL ADAPTER

294-CT40SM075150	ULTRADEX	CAT 40 X FMA 3/4" - 1.50 SHELL MILL HOLDER	1	\$59.00	
248-CAT40-SM100-0800	PIONEER	CAT 40 X FMA 1" X 8" SHELL MILL ADAPTER	1	\$199.00	

TAPPING CHUCK-QUICK CHANGE

231-CV40TT1291	ERI	CAT40-T/C TAPHOLDER SYSTEM #1 X 2.91"	1	\$149.00	
----------------	-----	---------------------------------------	---	----------	---

MORSE TAPER ADAPTER (MTA)

189-C40MT1	CENTAUR	CAT40(V40) #1 MORSE TAPER ADAPTER	1	\$49.00	
------------	---------	-----------------------------------	---	---------	---



Warehouse CLEARANCE





**ONLY 1 Left
CLEARANCE
\$799.00**



Order# 288-RWS405XST

TECO 4IN COMPACT VISE W/STEEL JAWS

FEATURES:

- Vise body and segment assembly manufactured from 4140 hardened steel for maximum rigidity, accuracy and clamping pressure.
- Machinable jaws allow maximum part contact ensuring a rigid, accurate workholding fixture.
- Vise accepts Toolex® SnapLock Jaws for maximum flexibility and reduced set-up time.
- Tool kit included (vise handle, pry wrench and hex key).
- Solid end construction eliminates jaw lift on fixed jaw end.
- Repeatability within $\pm .0005"$.

Order Number	Description	QTY	List Price	CLEAROUT	Vise Image
 HOMGE 338-ASC077X130S4	ASC-77 X 130S-4 FIVE AXIS, SELF CENTERING VISE 4-SCREW; 52X52MM BOLT PATTERN	7	\$1,188.00	\$594.00	

ONLY One Left!

SAVE 30%

96 HARDENED STEEL VISE JAW PAIR 125MM WIDE

Order# 385-M90JP-125STL

List Price: US\$ 290.00

CLEAROUT: CAN\$ 290.00

ONLY One Left!

SAVE 30%

96 SELF-CENTERING VICE ASSEMBLY
155MM CLAMP 125MM JAW WIDTH

Order# 385-M9MVC-155125

List Price: US\$ 2,080.00

CLEAROUT: CAN\$ 2,080.00

ONLY One Left!

SAVE 30%

96 RECTANGULAR BASE ASSEMBLY
156MM WIDTH X 192MM LENGTH W MOUNTING BORES

Order# 385-M9MBX-156192-02

List Price: US\$ 1,450.00

CLEAROUT: CAN\$ 1,450.00

ONLY One Left!

SAVE 30%

96 SELF-CENTERING VICE ASSEMBLY
255MM CLAMP 125MM JAW WIDTH

Order# 385-M9MVC-255125

List Price: US\$ 2,475.00

CLEAROUT: CAN\$ 2,475.00

75 X 100MM SELF CENTERING VISE

5th AXIS



Reduced for CLEAROUT
CAN\$ 899.00

On Hand: 2

LIST: US\$ 899.00
Order#: 312-V75100-L52

DV510 5" X 10" DEUCE VISE (BASE)

5th AXIS



Reduced for CLEAROUT
CAN\$ 1,499.00

On Hand: 1

**Jaws Sold Separately

LIST: US\$ 1,499.00
Order#: 312-DV510

DOVETAIL FIXTURE; 12MM X 32MM

5th AXIS

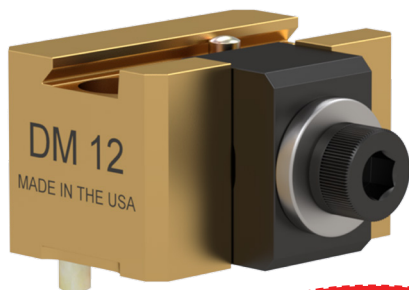

Reduced for CLEAROUT
CAN\$ 249.00

On Hand: 1

LIST: US\$ 249.00
Order#: 312-DM12

DV56 - 5" X 6" DEUCE VISE (BASE)

5th AXIS



Reduced for CLEAROUT
CAN\$ 849.00

On Hand: 2

**Jaws Sold Separately

LIST: US\$ 849.00
Order#: 312-DV56

DOVETAIL FIXTURE; 25MM X 37MM

5th AXIS



Reduced for CLEAROUT
CAN\$ 339.00

On Hand: 2

LIST: US\$ 339.00
Order#: 312-DM25

DOVETAIL & SERRATED HARD JAW SET

5th AXIS



Reduced for CLEAROUT
CAN\$ 529.00

On Hand: 2

LIST: US\$ 529.00
Order#: 312-DV56-3R

DOVETAIL FIXTURE; 50MM X 50MM

5th AXIS

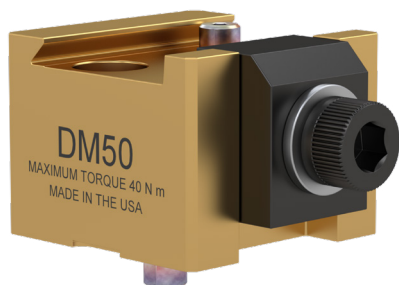

Reduced for CLEAROUT
CAN\$ 399.00

On Hand: 1

LIST: US\$ 399.00
Order#: 312-DM50

SELF-CENTERING VISE; 150MM X 250MM

5th AXIS



Reduced for CLEAROUT
CAN\$ 2,309.00

On Hand: 1

LIST: US\$ 2,309.00
Order#: 312-V6105M

RISER, D221 COMPATIBLE WITH 96MM QUICK CHANGE SYSTEM

 5th AXIS



Reduced for CLEAROUT
CAN\$ 892.00

On Hand: 1

LIST: US\$ 892.00
Order#: 312-R96-D221

ROCKLOCK 96MM TOP TOOLING - V75150X 1EA: R96-V75150X-1 [RISER]

 5th AXIS



Reduced for CLEAROUT
CAN\$ 1,529.00

On Hand: 1

LIST: US\$ 1,529.00
Order#: 312-R96-V75150X

ROCKLOCK 96MM TOP TOOLING - DM12 1EA: R96-DM12-1 [RISER]

 5th AXIS

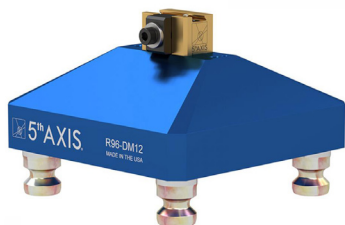

Reduced for CLEAROUT
CAN\$ 892.00

On Hand: 1

LIST: US\$ 892.00
Order#: 312-R96-DM12

ROCKLOCK 52MM LOW PROFILE BASE; 116MM DIAMETER

 5th AXIS



Reduced for CLEAROUT
CAN\$ 729.00

On Hand: 1

LIST: US\$ 729.00
Order#: 312-RL52A-4

ROCKLOCK 96MM TOP TOOLING - DV75150X-J1 1EA: R96-V75150X-1 [RISER]

 5th AXIS



Reduced for CLEAROUT
CAN\$ 1,739.00

On Hand: 1

LIST: US\$ 1,739.00
Order#: 312-R96-DV75150X-J1

ROCKLOCK 96MM LOW PROFILE BASE; 6" X 7"

 5th AXIS

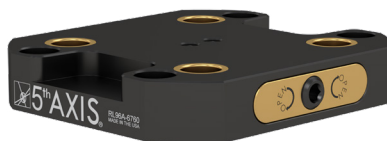

Reduced for CLEAROUT
CAN\$ 929.00

On Hand: 1

LIST: US\$ 929.00
Order#: 312-RL96A-6760

ROCKLOCK 96MM TOP TOOLING - V75100X 1EA: R96-V75100-1 [RISER]

 5th AXIS



Reduced for CLEAROUT
CAN\$ 1,439.00

On Hand: 1

LIST: US\$ 1,439.00
Order#: 312-R96-V75100X

ROCKLOCK 96MM LOW PROFILE BASE; 5" X 6"

 5th AXIS



Reduced for CLEAROUT
CAN\$ 879.00

On Hand: 1

LIST: US\$ 879.00
Order#: 312-RL96A-56

CLAMP ASSEMBLY FOR D1151S DOVETAIL CLAMP

5th AXIS



**Reduced for CLEAROUT
CAN\$ 78.75**

On Hand: 15

LIST: US\$ 78.75
Order#: 312-CDS25

ALUMINUM MACHINABLE SOFT JAW

5th AXIS

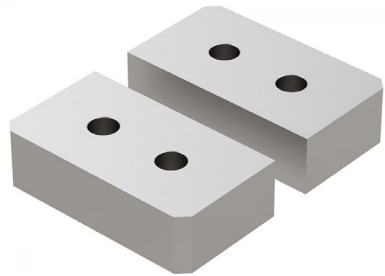

**Reduced for CLEAROUT
CAN\$ 99.00**

On Hand: 4

LIST: US\$ 99.00
Order#: 312-VAJ52

THUMB SCREW FOR V562 VISES

5th AXIS



**Reduced for CLEAROUT
CAN\$ 38.85**

On Hand: 1

LIST: US\$ 38.85
Order#: 312-TS13

STEEL MACHINABLE SOFT JAW

5th AXIS

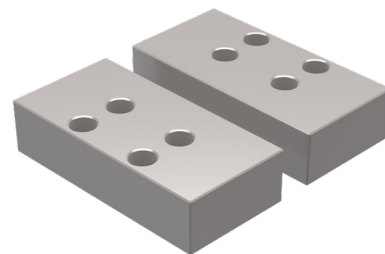

**Reduced for CLEAROUT
CAN\$ 139.00**

On Hand: 2

LIST: US\$ 139.00
Order#: 312-VSJ52X

MV-A1 MINI VISE

Tecma



**CLEAROUT
CAN\$ 87.00**

Mini-Vise reduces the time of changing from other jigs.
Mini-Vise applies to different platform.
Auxiliary:
Accuracy of JIG comes from the accuracy of fixed block
workpiece structure and diameter dowel pin (work origin)

LIST: \$ 150.00
Order#: 337-MVA1

On Hand: 1

**V562X LEFT TRUCK
V562X RIGHT TRUCK**

5th AXIS

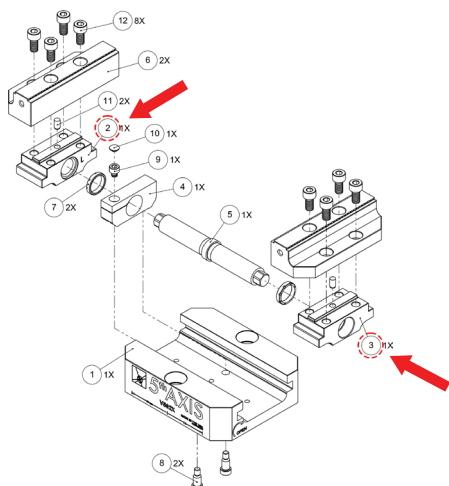

**Reduced for CLEAROUT
CAN\$ 99.00 EA**

LIST: US\$ 99.00 EA
Order#: 312-V562X-2L
Order#: 312-V562X-2R

**On Hand:
ONE EACH**

ITEM NO.	PART NUMBER	DESCRIPTION
1	V562X-1	BASE
2	V562X-2L	LEFT TRUCK
3	V562X-2R	RIGHT TRUCK
4	V562MX-3	CENTER BLOCK
5	V562M-4	LEAD SCREW
6	V562X-5	JAW
7	V56124-6	CENTER BLOCK RING
8	SB5VX	SHOULDER BOLT
9	-	SOCKET HEAD SCREW, M6x1x6mm
10	M6C	PLASTIC PLUG
11	M6X12.DP	DOWEL PIN, M6 X 12mm
12	-	SOCKET HEAD SCREW, M8x1.25x16mm
13	ANTI-SEIZE	ANTI-SEIZE (NOT SHOWN)
14	LP10	LOCATING PIN (NOT SHOWN)
15	TS13	THUMB SCREW (NOT SHOWN)

SELF CENTERING VICE - SCVR

Tecma



QTY: 1

**CLEAROUT
CAN\$ 499.00**

LIST: \$ 1,280.00
Order#: 337-SCVR90

1. Self Centring Precision Vise is suitable for 4 and 5 Axis CNC Rotary Table usage, either in horizontal or vertical machining.
2. Vise precision of its center repetition position is $\pm 0.01\text{mm}$.
3. Using high quality alloy steel. Slideway has high frequency heat treatment at HRC45 or more to keep the accuracy and its long use life.



Order #	Description	QTY	CLEAROUT
104-56058 ①	EO2007 PLASTIC EDGE OFF PLUS (RED) PKG (1)	10	\$3.00
214-FN55EO2000 ②	EO2000 EDGE-OFF PL (BLUE) HANDLE	1	\$3.00
104-56222 ③	NG3000 NG-3 HANDLE	23	\$8.00

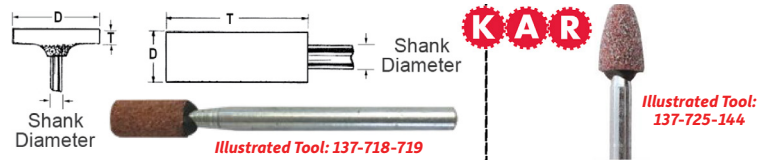

Order #	Description	QTY	List Price	CLEARANCE
137-718-703	W-153 MOUNTED WHEEL 1/4.INCH.SHANK	285	\$2.63	\$1.10
137-718-719	W-177 MOUNTED WHEEL 1/4.INCH.SHANK	232	\$2.75	\$1.15
137-725-263	W-163 MOUNTED WHEEL 1/8.INCH.SHANK	80	\$2.59	\$0.79
137-725-263G	W-163 MOUNTED WHEEL 1/8.INCH.SHANK-GREY	97	\$2.59	\$0.79
137-725-317	W-217 MOUNTED WHEEL 1/4.INCH. SHANK	4	\$2.81	\$1.20
137-725-144	B-44 MOUNTED WHEEL 1/8.INCH. SHANK	244	\$3.01	\$1.25

ABRASIVES CLEAROUT
SHOP ROLLS - ALUMINUM OXIDE

Made by
Union-Vis (Poland)



Order#	Description	QTY	List Price	BLOWOUT
158-100150	1.0" X 50YD-150 GRIT	15	\$34.00	\$14.99
158-100220	1.0" X 50YD-220 GRIT	22	\$34.00	\$14.99
158-100240	1.0" X 50YD-240 GRIT	9	\$34.00	\$14.99





**ONLY TWO LEFT
for \$20.00**

Order# 153-52-470-004
Telescopic Gauge 4pc 5/16-2"



Dial Indicator Test Set

Order# 153-52-520-101

**LAST One
for ONLY \$50.00**



FOWLER 6" CALIPER/1" INDICATOR/RULE KIT

Easy-to-read 0-6" "one Rev" dial caliper
Flexible ruler: 6", Grads. 10ths, 32nds, 64ths, & 100ths
Carbide tipped micrometer: 0-1", Graduation: .0001"
Supplied in fitted case.

Order #: 153-52-095-007

CLEARANCE: \$149.00

**4 ONLY
Left**



Order# 149-735-1064
**** ONLY 1 Left ****

**REDUCED
FOR CLEARANCE
NOW: \$39.33**



**ONLY
1
Left**

SET OF 6 SCREW THREAD MICROMETER ANVIL
Order# 149-713-0600
NOW: \$119.28



Order# 149-710-1021
NOW: \$60.70



Order# 149-735-1084
NOW: \$16.07

ASIMETO



**Reduced for
CLEARANCE
NOW: \$228.70**

**ONLY
1
Left**

0-3" / 0-75MM SET (3pcs)
Order# 149-711-6631



**LAST
ONE! NOW: \$109.24**

DIGITAL PROTRACTOR
W/MAGNETIC BASE
Order# 149-749-0162

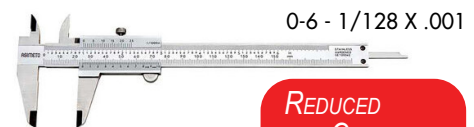

Order# 149-734-1061
**** ONLY 1 Left ****

**REDUCED
FOR CLEARANCE
NOW: \$43.29**



0-6" X .001" DIAL CALIPER
Order# 149-730-3061

NOW: \$46.69

**ONLY
1
Left**



2-3/8STEM.1/REV.0-100
Order# 149-740-2511

**ONLY
1
Left**

**NOW:
\$64.77**

TAPE MEASURE
CONTROLOK

\$14.99



**ONLY
2
Left**

Order# 107-AY1-33

SCHERR TUMICO

1" Solid Frame Micrometer
Order #: 113-02-0851-14



\$49.00
**Only
1
Left!**

SCHERR TUMICO

HURRY!



\$20⁰⁰

**** ONLY 8 in Stock ****
1/8" Travel Dial Indicator
Order #: 113-57-1506-00